

UBBINK BATTERY ENERGY STORAGE SYSTEM

Translation of the original
Operating instructions

Version 1.2

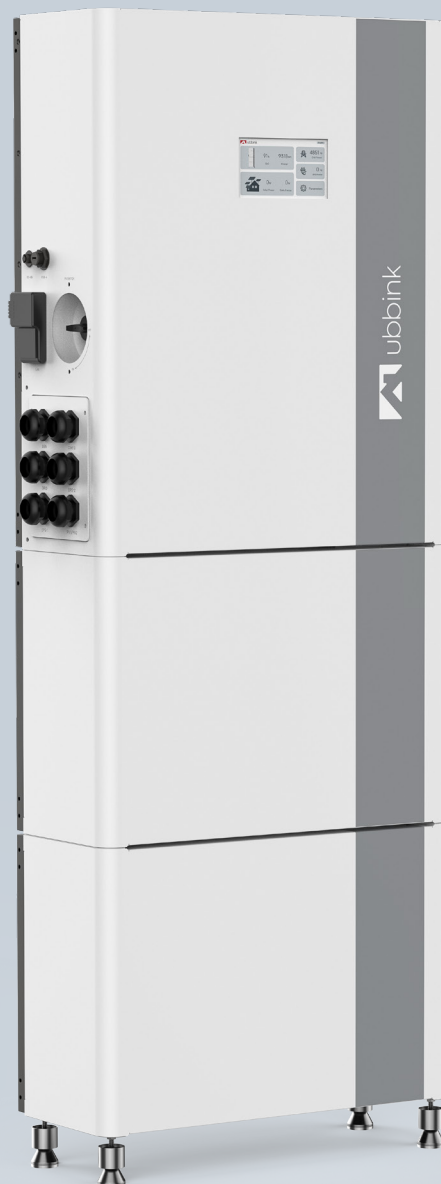



- ▷ Follow this Operating instructions for proper and safe use.
- ▷ Keep it in a safe place for later use.

Notations used

Instructions

- 1.** Do this.
 - 2.** Do that.
- ⇒ This is the interim result.
- 3.** Do the other.
- ✓ You have carried out the action.

Hazard classes and notes

	▷ Serious bodily injury / death probable
	▷ Serious bodily injury / death possible
	▷ Minor to moderate bodily injury possible
	▷ Material damage possible
	▷ Application tips / useful information

Abbreviations

AC	Alternating Current
DC	Direct current
EMS	Energy Management System
EPS	Backup Power Supply
EVU	Energieversorgungsunternehmen (energy supply company)
PE	Protective Earth conductor
PV	Photovoltaics
RCD	Residual Current Device
RCM	Residual Current Monitoring
SoC	State of Charge
SPD	Surge Protective Device

Product overview

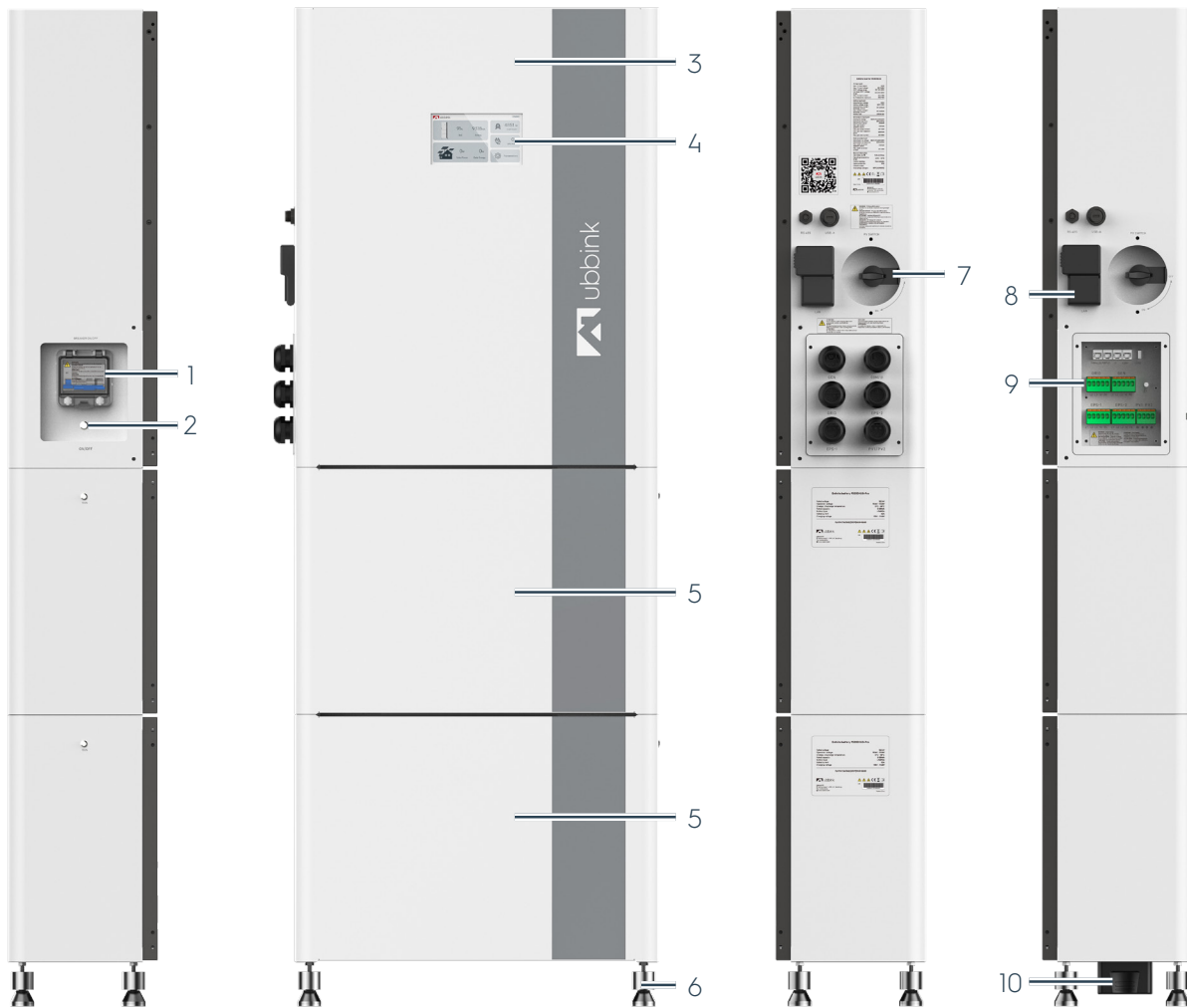

Pos.	Designation
1	Battery fuse
2	Main switch - system On / Off
3	Inverter
4	Display with touchscreen
5	Battery module - maximum 5 battery modules in series
6	4 levelling feet
7	PV connection On / Off
8	EMS (gateway)
9	Cable inlet and terminals
10	Serial terminal plug

Table of contents

1.	Safety	7
1.1	Intended use.....	7
1.2	Misuse.....	8
1.3	Warning signs.....	9
1.4	Mandatory signs.....	10
1.5	Target group of this Operating instructions.....	11
1.5.1	Personnel qualification.....	11
1.5.2	Qualification for individual activities.....	12
1.5.3	Personal protective equipment.....	12
1.6	Precautions for children and persons with limited abilities.....	13
1.7	Basic safety regulations.....	13
1.7.1	Hazard-conscious working.....	13
1.7.2	Modifications to the Ubbink Battery Energy Storage System.....	14
1.7.3	Firefighting.....	14
1.8	Risks and dangers.....	14
1.8.1	Slipping or tripping.....	14
1.8.2	Electric shock.....	15
1.8.3	Electrostatic discharge.....	15
1.8.4	Fire hazard.....	15
1.8.5	Batteries.....	16
1.8.6	Radiation.....	16
1.8.7	Hot surface.....	16
1.8.8	Magnets.....	17
1.8.9	Deep discharging.....	17
1.8.10	IT security and data protection.....	18
1.9	Response in an emergency.....	18
1.9.1	Earthquakes.....	19
1.10	Protective and warning devices.....	19
1.10.1	Surge protective device with surge arrester.....	20
1.10.2	Islanding protection.....	20
1.10.3	Inverter bypass.....	21
1.10.4	PE connection and leakage current.....	21
2.	Description of the Ubbink Battery Energy Storage System	22
2.1	General functional description.....	22
2.2	Directives and standards.....	25
2.2.1	Interfaces to external systems.....	26
2.2.2	Notes on the installation site.....	27
2.2.3	Signs on the Ubbink Battery Energy Storage System.....	28
2.2.4	Nameplate.....	30
2.3	Scope of delivery.....	32
2.3.1	Standard scope of delivery.....	32
2.3.2	Variants of the Ubbink Battery Energy Storage System.....	34

2.4	Technical data	35
2.4.1	Ambient conditions	35
2.4.2	Mechanical data	35
2.4.3	Inverter data	36
2.4.4	Recommended cables	37
2.4.5	Battery data	38
2.4.6	EMS data (gateway)	38
2.4.7	Software data	38
2.4.8	Service life of product and accessories	38
2.5	Operating concept	39
2.5.1	Controls, buttons and switches	39
2.5.2	Device displays	40
2.6	Touch display and operation of the inverter	41
2.6.1	Home (start screen)	41
2.6.2	Settings	42
2.6.3	Display of operating parameters	43
2.7	Profiles / scenarios	43
2.7.1	Self consumption	43
2.7.2	Peak shift	45
2.7.3	Battery priority	47
3.	Transport, storage, unpacking	48
3.1	Transport	48
3.2	Storage	48
3.3	Unpacking	48
4.	Operation preparation	49
4.1	Assembly	49
4.2	Electrical connection	54
4.3	Checks	59
4.3.1	Electrical checks	59
4.3.2	Mechanical checks	59
4.3.3	Configuration checks	60
4.3.4	Checks with the end customer	60
4.4	Commissioning	60
4.4.1	Switching on	60
4.4.2	Initial commissioning	61
4.4.3	Setting Peak Shift mode	69
4.5	Recommissioning	69
4.6	EMS integration and activation	70
4.6.1	Before installation	70
4.6.2	During installation: Connect the EMS to the Ubbink Battery Energy Storage System	70
4.6.3	Connect the EMS to the home network via Wi-Fi (not recommended)	72
4.6.4	During installation: Connecting devices to the EMS	73
4.6.5	After the installation: Using the Voltara Installer Centre as an installer	74

5.	Operation.....	76
5.1	Normal operation.....	76
5.2	Remote Control.....	76
6.	Malfunctions, messages and faults	77
6.1	Procedure in case of malfunctions	77
6.2	Troubleshooting.....	78
7.	Servicing and maintenance	82
7.1	Maintenance guidelines for battery modules.....	82
7.1.1	Avoiding deep discharging.....	82
7.1.2	Cycle life	82
7.2	Repair and replacement of parts.....	83
7.2.1	Transport packaging.....	83
7.3	Exchange of battery modules	83
8.	Decommissioning, dismantling, disposal.....	85
8.1	Decommissioning.....	85
8.2	Insulating electrically	85
8.3	Dismantling.....	87
8.4	Disposal and recycling.....	88
9.	Appendix.....	89
9.1	Software parameters.....	89
9.1.1	Home.....	89
9.1.2	Battery	89
9.1.3	Solar power.....	89
9.1.4	Power grid 1.....	90
9.1.5	Power grid 2.....	90
9.1.6	EPS 1.....	90
9.1.7	EPS 2.....	90
9.1.8	Settings.....	91
9.1.9	Profiles	91
9.1.10	Peak shift	91
9.1.11	Battery settings	91
9.1.12	Electrical Grid Standards.....	92
9.1.13	Function Settings.....	92
9.1.14	Operational Settings 1	93
9.1.15	Operational Settings 2	93
9.1.16	Time settings.....	93
9.1.17	Faults	94
9.2	Ubbink Warranty.....	94

1. Safety

1.1 Intended use

The Ubbink Battery Energy Storage System is used in the residential sector and is intended for the installation and operation indoors and in areas protected from the weather **only**.

The Ubbink Battery Energy Storage System is a home storage system with an integrated inverter that converts solar energy into direct current and stores the energy in batteries.

The Ubbink Battery Energy Storage System is used for:

- Optimisation of your own energy consumption,
- For storing energy in batteries for future use or
- For connecting to the public power grid.

The operating mode depends on the PV energy source and the user settings. The Ubbink Battery Energy Storage System can utilise the stored energy from the batteries and the current generated by the PV system in the inverter to continue to supply the connected consumers with power for a certain period of time in the event of a grid failure.

Only the following components may be used for the Ubbink Battery Energy Storage System:

- M6KH3UB-P5000HUB-Pro,
- M8KH3UB-P5000HUB-Pro,
- M10KH3UB-P5000HUB-Pro,
- M15KH3UB-P5000HUB-Pro.



Hint

- ▷ A maximum of 5 battery modules can be connected in series.

The Ubbink Battery Energy Storage System is intended for connection to a PV system with a capacity limit of approx. 700 nF.

The Ubbink Battery Energy Storage System may only be used with PV modules that comply with class A as per EN IEC 61730.

1.2 Misuse

Any use of the Ubbink Battery Energy Storage System other than or beyond that described in chapter "1.1 Intended use" on page 7 is considered not intended use and is therefore improper.

This applies in particular to the use of the Ubbink Battery Energy Storage System with components other than the original system components.

The use of the Ubbink Battery Energy Storage System in damp rooms and potentially explosive atmospheres (ATEX) **is prohibited**.

1.3 Warning signs











	Warning of a danger zone
	Electricity hazard
	Overhead or suspended load
	Explosive materials
	Flammable material
	Hot surface
	Non-ionising radiation
	Magnetic field
	Electrostatic Discharge (ESD)
	Hand injury
	Risk of tripping, floor-level obstacle
	Slippery surface

Table 1 Warning signs

1.4 Mandatory signs

	Refer to instruction manual
	Wear head protection
	Wear eye protection
	Wear a dust mask
	Wear insulating protective clothing
	Wear insulating protective gloves
	Wear insulating foot protection

Table 2 Mandatory sign

1.5 Target group of this Operating instructions



DANGER

Serious injury or death caused by untrained personnel handling the Ubbink Battery Energy Storage System.

- ▷ The Ubbink Battery Energy Storage System may only be handled by persons who have been trained by Ubbink International in the handling of the Ubbink Battery Energy Storage System.
- ▷ In particular, transport, assembly, installation, set-up, servicing, maintenance, troubleshooting, uninstallation, dismantling and disposal may only be performed after training by Ubbink International was completed.

1.5.1 Personnel qualification

This Operating instructions is aimed at personnel with the following qualifications:

Specialised personnel

The qualified personnel are able to perform the work assigned to them and to recognise and avoid possible dangers independently. This is due to their professional training, experience and knowledge, as well as knowledge of relevant regulations.

Trained / instructed personnel

Personnel who have been instructed about the tasks assigned to them and the possible dangers of improper behaviour and who have been trained if necessary. They were instructed on the necessary protective equipment and protective measures. Personnel to be trained, instructed or undergoing general training may only work under the constant supervision of experienced personnel.

Qualified electricians

Qualified electricians are trained for their specific tasks and are familiar with the relevant standards and regulations. They can perform work on electrical systems and recognise and avoid potential dangers independently. This is due to their professional training, experience and knowledge, as well as knowledge of relevant regulations.

1.5.2 Qualification for individual activities

What	Qualification
Transport	Specialised personnel
Storage	Specialised personnel
Repackaging	Specialised personnel
Assembly	Qualified electricians
Installation	Qualified electricians
Initial commissioning	Qualified electricians
Recommissioning	Trained / instructed
Set-up	Qualified electricians
Operation	Trained / instructed
Troubleshooting	Qualified electricians
Cleaning	Trained / instructed
Servicing, maintenance	Qualified electricians
Decommissioning	Qualified electricians
Uninstallation	Qualified electricians
Dismantling	Qualified electricians
Recycling, waste disposal	Trained / instructed

Table 3 Who-does-what matrix

1.5.3 Personal protective equipment

Use the following personal protective equipment during transport, assembly, installation, set-up, servicing, maintenance, troubleshooting, uninstallation, dismantling and disposal of the Ubbink Battery Energy Storage System:



- Protective goggles,
- Insulating protective clothing,
- Insulating protective gloves,
- Dissipative, insulating safety shoes.

Additional personal protective equipment may be required for certain activities. You will find safety instructions for this in the respective chapters of this Operating instructions.

1.6 Precautions for children and persons with limited abilities

Children and persons with reduced physical, sensory or mental capabilities or lack of experience or knowledge must **not** operate the Ubbink Battery Energy Storage System.

1.7 Basic safety regulations

Special safety regulations may apply to certain activities. Safety instructions and warnings can be found in the respective chapters of this Operating instructions.

The installer is responsible for ensuring that the safety instructions of this Operating instructions are observed. Before using the Ubbink Battery Energy Storage System, all personnel must have read and understood this Operating instructions, especially the safety-related information, before using the Ubbink Battery Energy Storage System.

Only persons who can be expected to carry out their work reliably are authorised as personnel. Persons whose ability to react is affected, e.g. by drugs, alcohol or medication, are **not** permitted.

1.7.1 Hazard-conscious working

Perform all work with or on the Ubbink Battery Energy Storage System carefully.

Only operate the Ubbink Battery Energy Storage System:

- As per intended use, aware of the risks and in compliance with these operating instructions,
- With all safety devices installed, functional and active,
- If the Ubbink Battery Energy Storage System is in perfect technical condition.

This also includes:

- Only perform electrical connection and/or maintenance work with the Ubbink Battery Energy Storage System switched off, fully discharged and secured against reactivation.

1.7.2 Modifications to the Ubbink Battery Energy Storage System

Modifications to the Ubbink Battery Energy Storage System are strictly prohibited.

Only use the accessories and cables supplied. Do **not** open housings or power-supply units.

If modifications are necessary, please contact Ubbink International in advance and obtain written confirmation of your authorisation.

Unauthorised modifications will invalidate the warranty and may require a reassessment of CE conformity. No liability is accepted for damage caused by overcurrent.

1.7.3 Firefighting

Fire Suppression System: Each Ubbink battery module contains an internal aerosol-based fire suppression system.

Only extinguish the Ubbink Battery Energy Storage System with a CO₂ fire extinguisher.

Provide suitable extinguishing agents in the vicinity of the Ubbink Battery Energy Storage System as a precaution.

Fire detection - smoke detectors

Install certified smoke detectors in the immediate vicinity of the Ubbink Battery Energy Storage System. Smoke detectors serve as an additional warning and help you fighting fires by allowing you to react more quickly.

1.8 Risks and dangers

1.8.1 Slipping or tripping



Minor injuries possible due to slippery surfaces or tripping hazards.

- ▷ Lay all cables so that there are not a tripping hazard (e.g. cable duct).
- ▷ Remove loose cables and objects from the floor of the work area.
- ▷ Always keep the work area clean, tidy and dry.
- ▷ Wear safety shoes.

1.8.2 Electric shock



Danger to life due to electricity hazard.

- ▷ Have work on the Ubbink Battery Energy Storage System performed by qualified electricians **only**.
- ▷ Make sure that the DC input voltage is below the maximum value.
- ▷ Work on the Ubbink Battery Energy Storage System with insulated tools **only**.
- ▷ **Never** dismantle parts of the Ubbink Battery Energy Storage System unless it is specifically described in this Operating instructions.
- ▷ **Never** touch the poles of the PV connection device.
- ▷ Do **not** operate any live components or cables if they are disconnected from the Ubbink Battery Energy Storage System.
- ▷ **Always** wait at least 5 minutes after switching off the Ubbink Battery Energy Storage System **before** disconnecting or connecting cables or connections.
- ▷ Use a multimeter to check that the link voltage capacitors are fully discharged **before** disconnecting the DC connection, the battery and the mains coupler or opening the Ubbink Battery Energy Storage System.

1.8.3 Electrostatic discharge



Serious material damage to electronic components possible due to electrostatic discharge (ESD).

- ▷ Do not touch any electronic components or connections, e.g. on the Energy Management System (EMS).
- ▷ Ground yourself **before** working on the EMS.

1.8.4 Fire hazard



Danger to life due to incorrect ambient conditions.

- ▷ Keep highly flammable and explosive materials away from the installation site of the Ubbink Battery Energy Storage System.
- ▷ Always keep the installation site of the Ubbink Battery Energy Storage System dry, clean and tidy.
- ▷ Do **not** operate the Ubbink Battery Energy Storage System in areas at risk of flooding.

1.8.5 Batteries



Serious injuries possible due to improper handling of batteries.



▷ Have work on the Batteries carried out by qualified electricians **only**.



▷ Do not wear watches, rings or other metal objects during installation.

▷ Do **not** place any metal parts, e.g. tools, on the batteries.

▷ Use insulated tools **only**.

▷ Switch off the consumers connected to the batteries before removing the battery terminals.

▷ Wear dissipative, insulating safety shoes and insulating protective gloves.

1.8.6 Radiation



Injuries possible due to non-ionising radiation.

▷ **Never** remove covers.

▷ Keep a distance of more than 20 cm to the Ubbink Battery Energy Storage System.

▷ If you need to get closer than 20 cm to the Ubbink Battery Energy Storage System for certain work, minimise the time you spend there.

1.8.7 Hot surface



Burns possible due to hot surfaces.

▷ During operation, **only** touch the touchscreen to operate the Ubbink Battery Energy Storage System.

▷ **Never** remove covers.

▷ Wait at least 30 minutes after switching off the Ubbink Battery Energy Storage System before starting any work on it.

1.8.8 Magnets



Serious internal injuries possible if magnets are swallowed.

- ▷ Keep magnets out of the reach of children.
- ▷ If one or more magnets are swallowed, seek medical help immediately.

1.8.9 Deep discharging

The battery is factory-set to a minimum **State of Charge** (SoC) of 20%, see menu setting State of Charge (%). Ubbink International does **not recommend** a charge depth lower than 20% SoC.

A charge depth of lower than 10% SoC can affect the accuracy of the state of charge value, especially if you operate the Ubbink Battery Energy Storage System over a longer period of time with a low state of charge.

Charge the battery fully at regular intervals, especially if you are operating the Ubbink Battery Energy Storage System in peak load self-consumption mode.

Operation

If the Ubbink Battery Energy Storage System is in operation and the battery is disconnected from the grid and the PV system for > 5 days:

- Charge the battery to at least 50%.

Storage

If you store the Ubbink Battery Energy Storage System > 24h:

- Disconnect the battery using the battery disconnect switch to prevent deep discharging and irreversible damage to the battery.
- Disconnect the inputs for PV, GRID and EPS to avoid leakage currents.

1.8.10 IT security and data protection

To be able to use the full range of functions of the EMS, you must connect the EMS to the local network and the internet.

Although the communication path between the EMS and the services on the internet is secured as per the current state of the art, the connection to a network / the internet harbours security risks. Third parties could gain access to the network and misuse the energy data.

To protect sensitive data, only use secure passwords and keep them secret.

The protection of personal energy data is a top priority for Ubbink International. The EMS platform is constantly kept up to date with the latest security technology to ensure that energy data can only be accessed by the owner and authorised participants.



Hint

- ▷ The data collected by the EMS may differ from the data from the EVU meter.
 - ▷ The EMS data is **not** suitable for billing purposes.
-

1.9 Response in an emergency

If it is safe to do so, switch off the Ubbink Battery Energy Storage System and disconnect the Ubbink Battery Energy Storage System from the power supply:

- In case of risk of injury,
- In case of risk of damage to the Ubbink Battery Energy Storage System or other objects.

In the event of an accident, take immediate action and call the local emergency number.

1.9.1 Earthquakes

The Ubbink Battery Energy Storage System is designed to be stable.

Check the anchoring in the wall annually.

1.10 Protective and warning devices

Before each start-up, all safety devices must be properly installed, functional and active.



Serious injuries possible if safety devices are deactivated.

- ▷ Safety devices must be fully functional before you put the Ubbink Battery Energy Storage System back into operation.
- ▷ Install safety devices immediately after completing work that requires them to be dismantled.

Safety devices may only be removed if:

- There are **no** persons in the danger zone of the Ubbink Battery Energy Storage System,
- The Ubbink Battery Energy Storage System is switched off, fully discharged and secured against reactivation.

1.10.1 Surge protective device with surge arrester

When installing PV power generation systems, provide for surge protection (Surge Protective Device, SPD) with surge arresters.

Install suitable surge protection devices on the PV input side and on the grid side of the inverter.

Overvoltage, e.g. due to lightning strikes, can occur both on the line of the PV system and on the AC cables leading to the building.

If necessary, consult specialist personnel for lightning protection during installation.

For the protection of the DC system, install:

- Surge protection devices (SPD type 2) on the inverter and on the PV array between the inverter and PV generator.
- If the voltage protection level of the surge arresters is more than 1,100 V, an additional SPD type 3 is required.

For the protection of the AC system, install:

- Surge protective devices (SPD type 2) must be installed at the main input point of the AC power supply (at the consumer disconnection point) between the inverter and the meter / distribution network.
- SPD (test pulse D1) for the signal feed as per EN 61632-1.



Hint

- ▷ A spark gap is **not** suitable for use in direct current circuits.

1.10.2 Islanding protection

The inverter is provided with "islanding protection". It is preconfigured by default in the factory settings and is active on delivery.

In case of grid malfunctions or power failures, the grid-connected inverter switches off automatically to ensure safe disconnection from the grid.

1.10.3 Inverter bypass

The inverter of the Ubbink Battery Energy Storage System is provided with a bypass function. In case of a malfunction in the inverter, it switches to bypass mode.

In bypass mode, the electrical current is fed directly from the input source to the output and there is no reversal or conditioning.

The installer is responsible for ensuring that the bypass function is supplemented with additional safety features to fulfil local regulations.

1.10.4 PE connection and leakage current



WARNING

Danger to life, malfunction and increased electromagnetic load possible due to improper earthing.

- ▷ Ensure that the earth conductor is sufficiently dimensioned as per the safety regulations.
- ▷ Do **not** connect the earthing terminals of the Ubbink Battery Energy Storage System in series for multiple installations.
- ▷ If you use a residual current device (RCD) or residual current monitoring (RCM) for protection in case of direct or indirect contact, you must use a type B RCD or RCM on the supply side of the Ubbink Battery Energy Storage System.

The end application must monitor the protective earth conductor by means of a residual current device (RCD) with a rated residual current of ≤ 240 mA, which automatically switches off the Ubbink Battery Energy Storage System in case of a fault.

2. Description of the Ubbink Battery Energy Storage System

2.1 General functional description

The Ubbink Battery Energy Storage System is a home storage system with an integrated inverter that converts solar energy into direct current and stores the energy in batteries.

The Ubbink Battery Energy Storage System is used for:

- Optimisation of your own energy consumption,
- For storing energy in batteries for future use or
- For connecting to the public power grid.

The operating mode depends on the PV energy source and the user settings. The Ubbink Battery Energy Storage System can utilise the stored energy from the batteries and the current generated by the PV system in the inverter to continue to supply the connected consumers with power for a certain period of time in the event of a grid failure.

The Ubbink Battery Energy Storage System is intended for connection to a PV system with a capacity limit of approx. 700 nF.

The Ubbink Battery Energy Storage System may **only** be used with PV modules that comply with class A as per EN IEC 61730.

In general, the Ubbink Battery Energy Storage System is operated via the following options:

- Touchscreen directly on the outer housing of the Ubbink Battery Energy Storage System,
- "Voltara Home" via a mobile device.

Description of the Ubbink Battery Energy Storage System General functional description

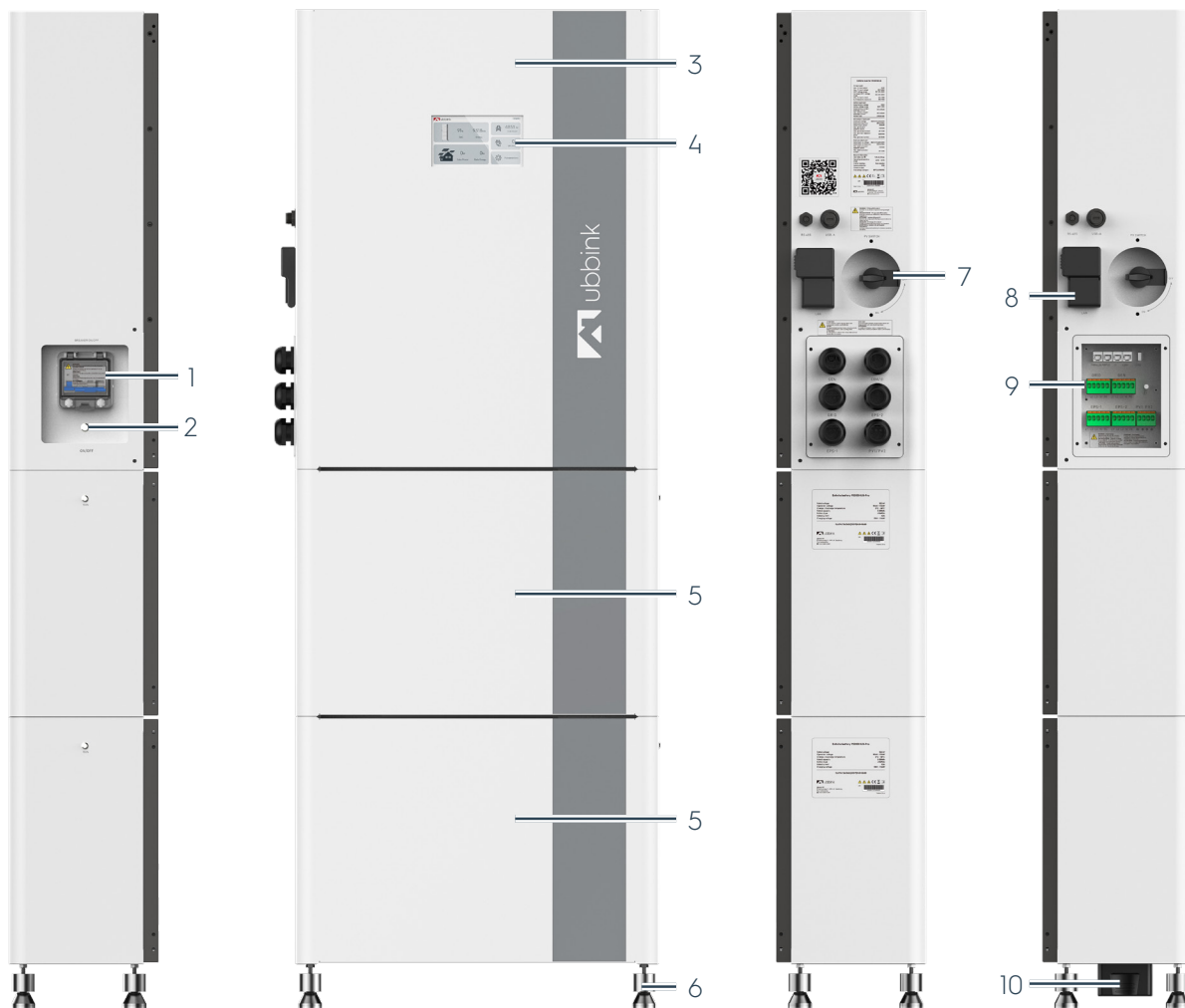

Figure 1 Overview of the Ubbink Battery Energy Storage System

Pos.	Designation
1	Battery fuse
2	Main switch - system On / Off
3	Inverter
4	Display with touchscreen
5	Battery module
6	4 levelling feet
7	PV service disconnect On / Off
8	EMS (gateway)
9	Cable inlet and terminals
10	Serial terminal plug



Figure 2 Inverter of the Ubbink Battery Energy Storage System

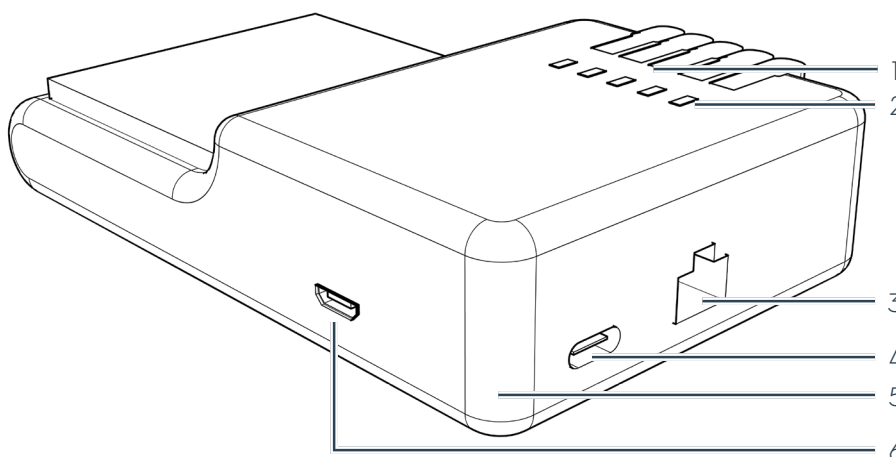

Figure 3 EMS structure

Pos.	Designation
1	RS-485 connectors
	1: RS-485A / Digital Out 1 (brown wire)
	2: RS-485B / Digital Out B (blue wire)
	3: Ground
	4: S0+, S0- Power
2	Status LEDs 1 ... 5
	RJ45, Ethernet
4	USB-C, power supply
5	Power LED
6	Micro-USB

2.2 Directives and standards

Product name / designation	Ubbink Battery Energy Storage System
Serial number, type number or batch number	See chap. "2.2.4 Nameplate" on page 30
Conformity with regulations and standards	<ul style="list-style-type: none"> ▪ 93/68/EU ▪ 2014/30/EU ▪ 2014/35/EU ▪ 2011/65/EU ▪ 2012/19/EU ▪ 2006-66-EU ▪ IEC 61000-6-1 to 61000-6-4 ▪ DIN EN 62116 ▪ DIN EN 50549 ▪ VDE-AR-N-4105 ▪ IEC 61683 ▪ IEC 62619 ▪ IEC 60529 ▪ UN38.3
Product versions	<ul style="list-style-type: none"> ▪ Ubbink Battery Energy Storage System M6KH3UB-P5000HUB-Pro ▪ Ubbink Battery Energy Storage System M8KH3UB-P5000HUB-Pro ▪ Ubbink Battery Energy Storage System M10KH3UB-P5000HUB-Pro ▪ Ubbink Battery Energy Storage System M15KH3UB-P5000HUB-Pro

Table 4 Identification features

2.2.1 Interfaces to external systems

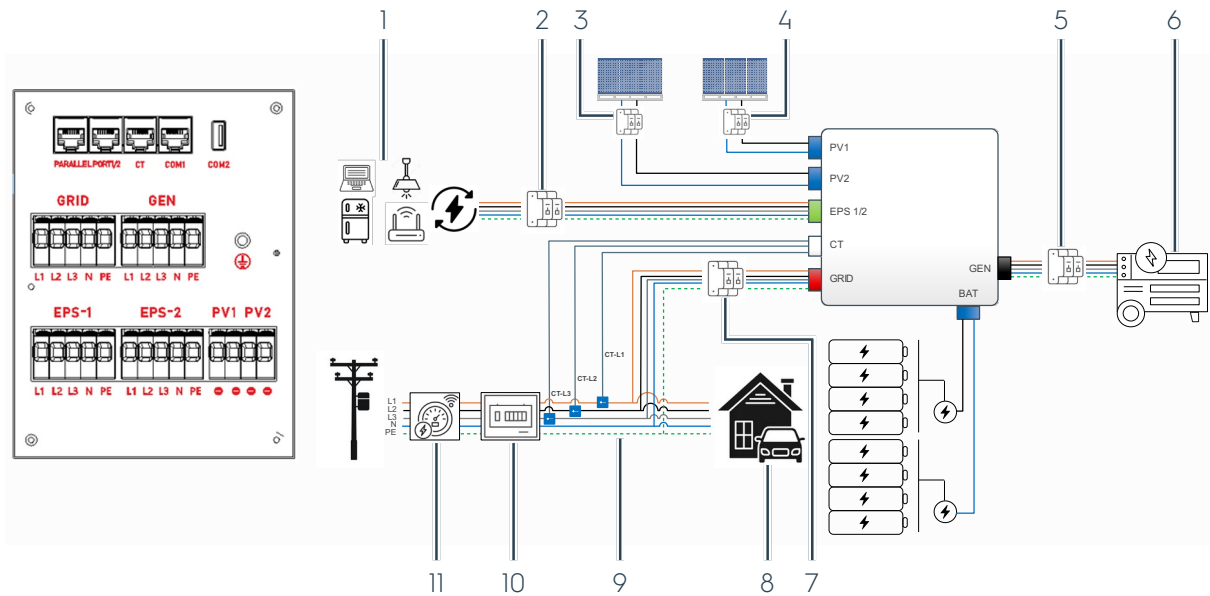

Figure 4 Wiring diagram of the Ubbink Battery Energy Storage System

Pos.	Designation
1	Critical loads Critical EPS loads are limited to the rated power of the inverter
2	EPS circuit breaker (on site)
3	PV2 circuit breaker (on site)
4	PV1 circuit breaker (on site)
5	GEN EPS circuit breaker (on site)
6	Generator (GEN)
7	GRID IN / OUT circuit breaker (on site)
8	In-house consumers CT-L1, CT-L2, CT-L3 - arrow pointing in the direction of the grid
9	Current transformer installed directly after the maintenance switch for the in-house load (included in the assembly accessories)
10	Main switch (on site)
11	Intelligent meter (smart meter) - optional accessory

2.2.2 Notes on the installation site



WARNING

Danger to life and serious material damage possible due to incorrect ambient conditions.

- ▷ Observe the ambient conditions, see chapter "2.4.1 Ambient conditions" on page 35.
- ▷ Avoid direct exposure to the weather, e.g. sunlight, rain and snow.
- ▷ Maintain the required clearance around the Ubbink Battery Energy Storage System to ensure adequate ventilation.
- ▷ Install the Ubbink Battery Energy Storage System close to the PV system to keep cable runs as short as possible and minimise DC losses.

Floor condition	Even
Load distribution	Selective
Levelling	Possible via the adjustable feet
Alignment	In balance
Accessibility	
Clearance on both sides, the front and the top	200 mm
Fastening	Wall bracket with screws from the assembly accessories

Table 5 Requirements for the installation site

2.2.3 Signs on the Ubbink Battery Energy Storage System

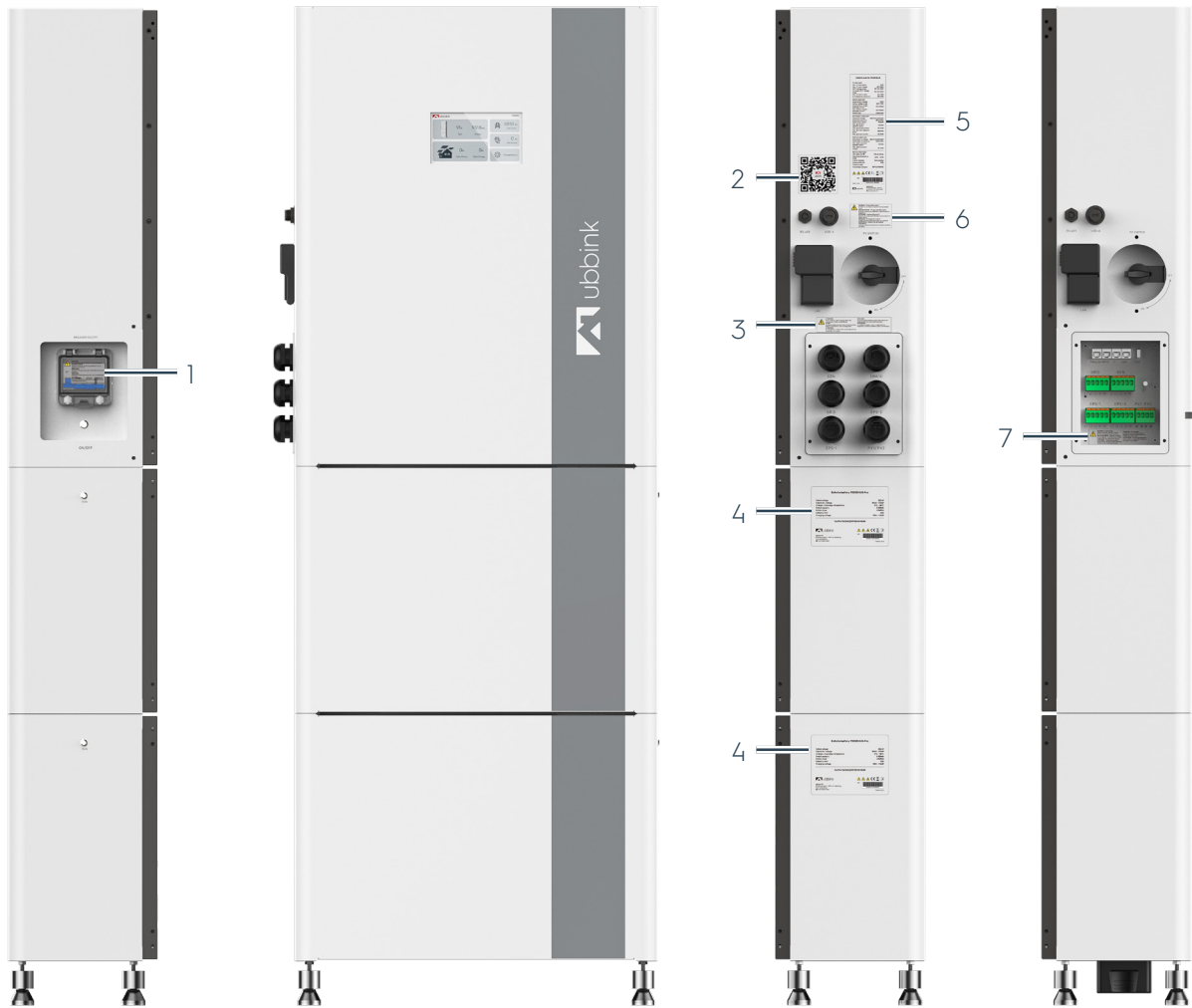

Figure 5 Signs on the Ubbink Battery Energy Storage System

Pos.	Designation
1	Warning no. 1
2	QR code to the digital version of this Operating instructions
3	Warning no. 2
4	Battery nameplate
5	Inverter nameplate
6	Warning no. 3
7	Warning no. 4

Warning no. 1 (pos. 1)



Warning!

- ▷ Switch off the battery system isolator to isolate the device.
-

Warning no. 2 (pos. 3)



Notice!

- ▷ The components may still be energised even when the main switch is switched off.
-

Warning no. 3 (pos. 6)



Warning - PV system DC isolator!

- ▷ Contains live components in daylight.
-

Warning no. 4 (pos. 7)



Warning - Dual Supply!

- ▷ Disconnect all live connections and the mains connection before performing any work.
-

2.2.4 Nameplate

The following figures show examples of the nameplates of the Ubbink Battery Energy Storage System.

1	Ubbink inverter M15KH3UB
2	DC-PV input port Max. PV input power 22.5 kWp Max. PV input voltage 1000 Vdc PV operational range 180-860 Vdc PV full power MPPT voltage 430-860 Vdc Nominal PV input current 20 A 20 A Max. short-circuit current 30 A 30 A
3	DC-Battery input port Rated battery voltage 400 Vdc Battery voltage range 125-600 Vdc Rated battery charge / discharge current 40/40 A Max. battery charge / discharge current 50/50 A Cell type Lithium-ion (LFP)
4	AC-Grid input/output port Grid nominal voltage 3/N/PE 230/400 Vac Grid nominal frequency 50/60 Hz Rated output power 15000 W Max. grid output apparent power 16500 VA Max. grid output current 23.8 A Max. grid input apparent power 30000 VA Max. grid input current 47.6 A
5	AC-EPS output (backup) port Nominal output voltage 3/N/PE 230/400 Vac Rated back-up frequency 50/60 Hz Nominal output power 15 kVA Nominal output power per Phase 21.7 A
6	General information Adjustable cos (φ) 0.8ind..0.8cap Operational temperature -25°C - +60°C Inverter topology Non-Isolated Ingress level IP65 Protective class I Overvoltage category II(PV),III(MAINS)
7	
8	S/N Made in PRC
9	ubbink CS Wismar GmbH - www.ubbink.com An der Westtangente 1 - D-23966 Wismar - Germany

Figure 6 Inverter nameplate (example)

Pos.	Designation
1	Type designation
2	PV input technical data
3	Battery input technical data
4	Grid output / input port technical data
5	Backup output port technical data
6	Ambient conditions, protection class
7	Wait at least 5 minutes after switching off.
8	Follow the instructions.
8	Serial number (barcode)
9	Manufacturer address

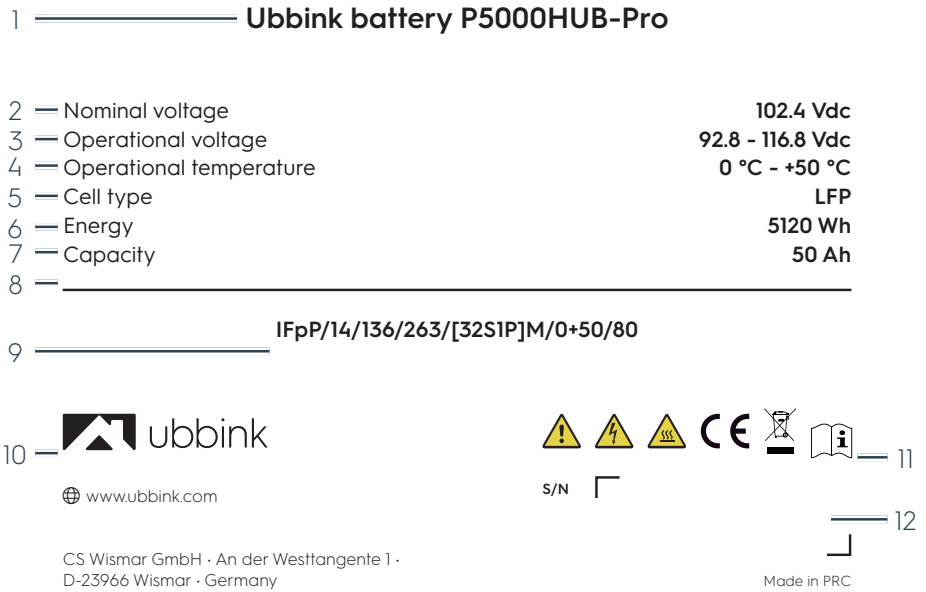



Figure 7 Battery nameplate (example)

Pos.	Designation
1	Type designation & Model
2	Rated voltage
3	Operating voltage
4	Charging and operating temperature
5	Rated capacity
6	Battery type
7	Rated current
8	Charge voltage
9	Technical information on the cell type
10	Manufacturer address
11	 Do not dispose of old electrical appliances with the household waste / residual waste.
11	 Follow the instructions.
12	Serial number (barcode)

2.3 Scope of delivery

2.3.1 Standard scope of delivery



Figure 8 These components are standard in the Ubbink Battery Energy Storage System

The following components are included in the scope of delivery:

Pos.	Designation
1	Inverter
2	Display with touchscreen
3	Battery module
4	EMS (gateway)
5	Cable inlet and terminals
6	4 levelling feet

Accessories and assembly material

Figure	Designation
	1x EMS with communication cable RS485
	1x EMS - power supply cable I USB-C - USB-A
	1x CT Cable and 2.0M CAT6 LAN Cable
	Standard battery plug
	2x wall bracket per battery
	2x wall bracket for inverter
	8x M5x12 for inverter 8x M5x12 per battery module 6x M6x60 expansion screw
	24x cable lugs / wire end ferrules
	4x adjustable feet M8
	1x interface panel
	1x Quick Guide

2.3.2 Variants of the Ubbink Battery Energy Storage System

Depending on the order, 2 or 3 battery modules may be included in the scope of delivery.

Expansion pack

With the expansion pack you can connect up to 5 battery modules to the Ubbink Battery Energy Storage System.

When positioning the additional battery tower on the right-hand side of the Ubbink Battery Energy Storage System, a 1.5m expansion cable is required; when positioning it on the left-hand side, a 3m expansion cable is required.

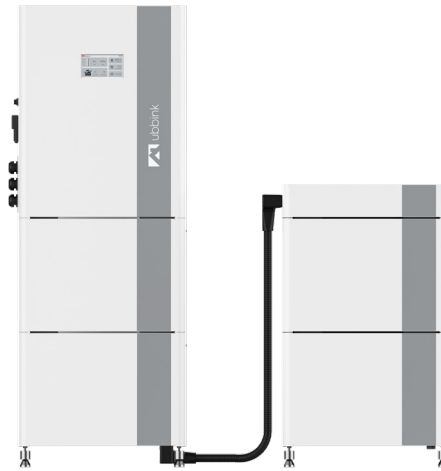

Figure 9 Expansion pack for 4 battery modules (example)

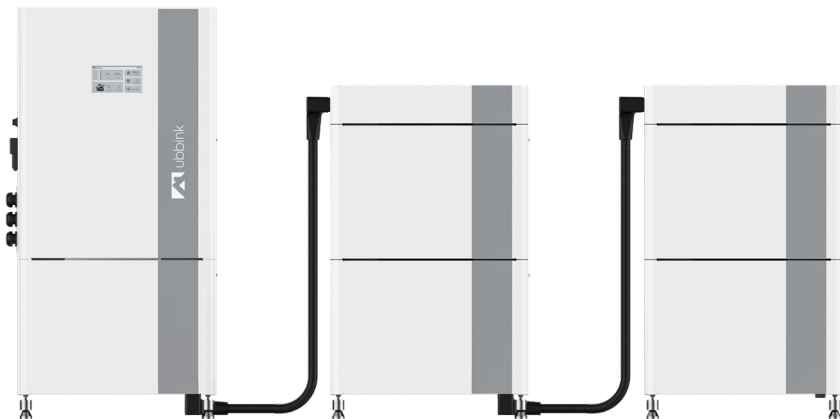

Figure 10 Expansion pack for 5 battery modules - variant A (example)

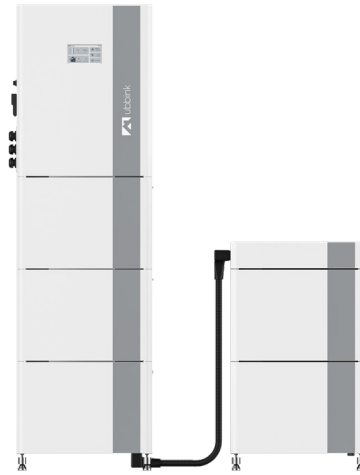
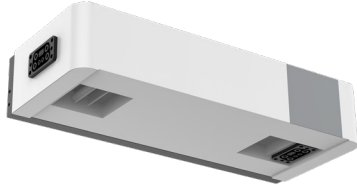



Figure 11 Expansion pack for 5 battery modules - variant B (example)

Expansion pack accessories

Figure	Designation
	Battery cover for serial connection (including 4 extra feet)
	Serial connection cable

2.4 Technical data

2.4.1 Ambient conditions

Parameters	Inverter	Battery	EMS
Operating temperature [°C]	+0 ... +50	+0 ... +50	+0 ... +50
Storage temperature [°C]	-10 ... +55	-10 ... +55	-10 ... +55
Humidity [%]	5 ... 95	5 ... 95	15 ... 85
Operating height a.s.l. [m]	< 2 000	< 2 000	< 2 000

Table 6 Ambient conditions

2.4.2 Mechanical data

Parameters	Inverter	Battery	EMS
Dimensions (L x W x H) [mm]	610 x 252 x 770	610 x 252 x 415	65 x 24 x 102
Weight approx. [kg]	65	51	0.09
IP code	65	65	20

Table 7 Mechanical data

2.4.3 Inverter data

Parameters		M6KH3UB	M8KH3UB	M10KH3UB	M15KH3UB
PV Nominal input power [kW]		6	8	10	15
PV Max. input power [kWp]	< 10 min	6.6	8.8	11	16.5
	< 85 sec	7.2	9.6	12	18
	< 20 msec	8	12	15	22.5
Nominal input current per MPPT [A]		18 / 18	18 / 18	18 / 18	20 / 20
Max. short-circuit per MPPT [A]		25 / 25	25 / 25	25 / 25	30 / 30
PV number of solar trackers		2	2	2	2
PV number of strings per solar tracker		1	1	1	1
Min. number of battery modules		2	2	2	3
AC Nominal input current per phase [A]		17,3	23,1	28,8	43,4
AC Max. input current per phase [A]		19,0	25,5	31,9	47,6
AC Nominal output current per phase [A]		8,7	11,5	14,4	17,3
AC Max. output current per phase [A]		9,5	12,7	15,9	23,8
AC Nominal Output Power [kVa]		6	8	10	15
AC Max. output apparent power < 10 min [kVa]		6,6	8,8	11,0	16,5
AC Peak output apparent power to 60s [kVa]		7,2	9,6	12,0	18,0
Grid Nominal Voltage [V AC]		230/400	230/400	230/400	230/400
Grid Nominal Frequency [Hz]		50/60	50/60	50/60	50/60
Power factor - PF (lag / lead)		0.9 / 0.9	0.9 / 0.9	0.9 / 0.9	0.9 / 0.9
AC output topology		3W+N+PE	3W+N+PE	3W+N+PE	3W+N+PE
Maximum efficiency		97,9%	97,9%	98,2%	98,8%
Euro efficiency		97,2%	97,2%	97,5%	97,8%
THDI [%]		< 2	< 2	< 2	< 2
THDv [%]		< 2	< 2	< 2	< 2
Automatic switching time [msec]		< 10	< 10	< 10	< 10
PV switch-on voltage [V DC]		> 125	> 125	> 125	> 125
Nominal Input Voltage [V DC]		600	600	600	600
PV operating voltage [V DC]		180 ... 860	180 ... 860	180 ... 860	180 ... 860
PV max. safety voltage [V DC]		1 000	1 000	1 000	1 000
PV efficiency at 850 V [%]		≥ 99.5	≥ 99.5	≥ 99.5	≥ 99.5
Max. MPPT efficiency [%]		99,9	99,9	99,9	99,9
GEN connection		3 phases	3 phases	3 phases	3 phases
GEN Input Power (kW)		6	8	10	15
GEN Input Current per Phase (A)		13	13	13	20

Table 8 Inverter data

2.4.4 Recommended cables

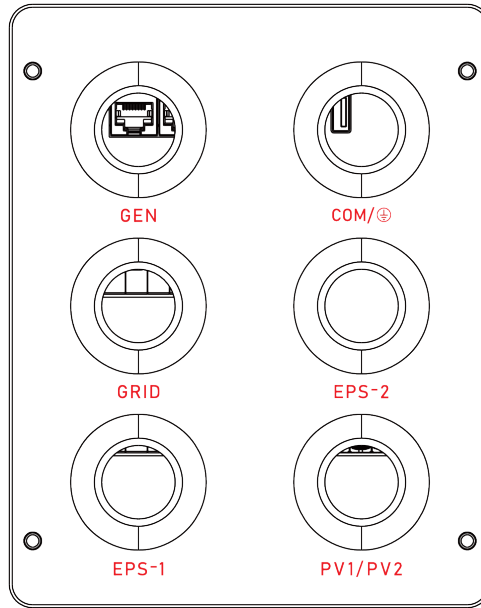

Figure 12 Cable inlet and terminals on the inverter

AC connection		L1	L2	L3	N	PE
GRID / GEN /	Colour	Brown	Black	Grey	Blue	Green / yellow
EPS-1 / EPS-2	Cross-section [mm ²]	4 - 6	4 - 6	4 - 6	4 - 6	2.5 - 6
	Current [A]	20	20	20	20	< 1

Table 9 AC connection: Recommended cables

DC connection		(+)	(-)
PV-1 / PV-2	Colour	Blue	Black
	Cross-section [mm ²]	2.5 - 6	2.5 - 6
	Current [A]	18	18

Table 10 DC connection: Recommended cables

Earthing connection		Earthing
COM / ⊕	Colour	Green / yellow
	Cross-section [mm ²]	2.5 - 6
	Current [A]	< 1

Table 11 Earthing connection: Recommended cables

2.4.5 Battery data

Parameters	P5000HUB - 1 battery module
Cell chemistry	LiFeO ₄ / LFP
Rated capacity [Ah]	50
Nominal Battery Energy [kWh]	5,12
Usable Battery Energy [kWh]	4,6
Rated charge power [W]	2 560
Operating voltage [V DC]	92.8 ... 113.6
Efficiency (DC) [%]	> 98.5

Table 12 Battery data for 1 battery module

2.4.6 EMS data (gateway)

Parameters	EMS
Min. power consumption [W]	2
Max. power consumption [W]	10
Mains frequency [Hz]	50

2.4.7 Software data

Parameters	Inverter	EMS
Communication connections	LAN	LAN

Table 13 Software data

2.4.8 Service life of product and accessories

Parameters	Battery
Year of manufacture	See chapter "2.2.4 Nameplate" on page 30
Expected full life cycles at 25°C	6 000

Table 14 Service life

SoC [%]	Ambient temperature [°C]								Discharge power [%]
	0 ... 5	5 ... 10	10 ... 15	15 ... 20	20 ... 40	40 ... 45	45 ... 50	50 ... 55	
0 ... 10	0	0	0	0	0	0	0	0	
10 ... 20	12	12	60	100	60	20	12	4	
20 ... 70	20	40	60	100	100	60	40	4	
70 ... 90	20	40	60	100	100	60	40	4	
90 ... 95	20	40	60	100	100	60	40	4	
95 ... 100	20	40	60	100	100	60	40	4	

Table 15 Discharge power according to ambient temperature

2.5 Operating concept

2.5.1 Controls, buttons and switches



Figure 13 Controls on the inverter of the Ubbink Battery Energy Storage System

Pos.	Designation
1	PV service disconnect On / Off
2	Display with touchscreen
3	Battery fuse
4	Main switch - system On / Off

2.5.2 Device displays

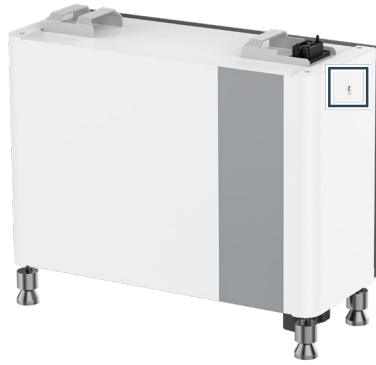

Figure 14 Battery module indicator light

Each battery module has an indicator light on the side.

Colour / status	Meaning
Off	Battery switched off / undervoltage
Green, glowing	Status OK
Green, flashing	SoC < 20%

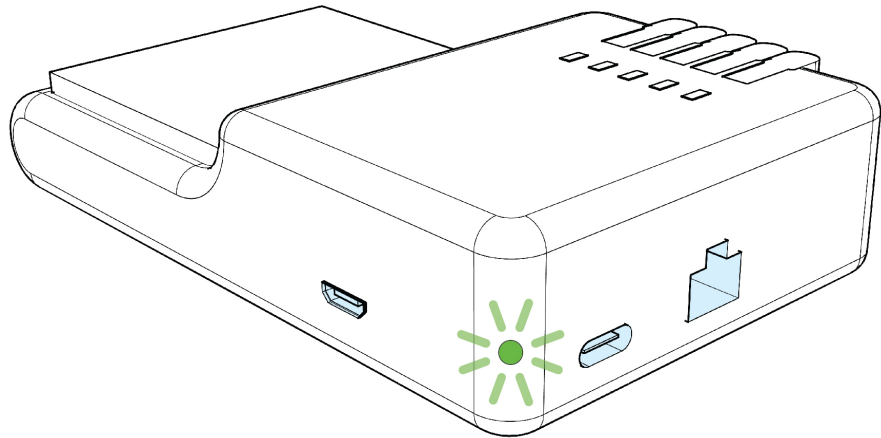

Figure 15 Power LED on the EMS

Colour / status	Meaning
Off	Power supply interrupted
Red, glowing	Supply voltage is present
Orange, flashing	EMS starts up
Green, glowing	EMS is operational

2.6 Touch display and operation of the inverter

2.6.1 Home (start screen)

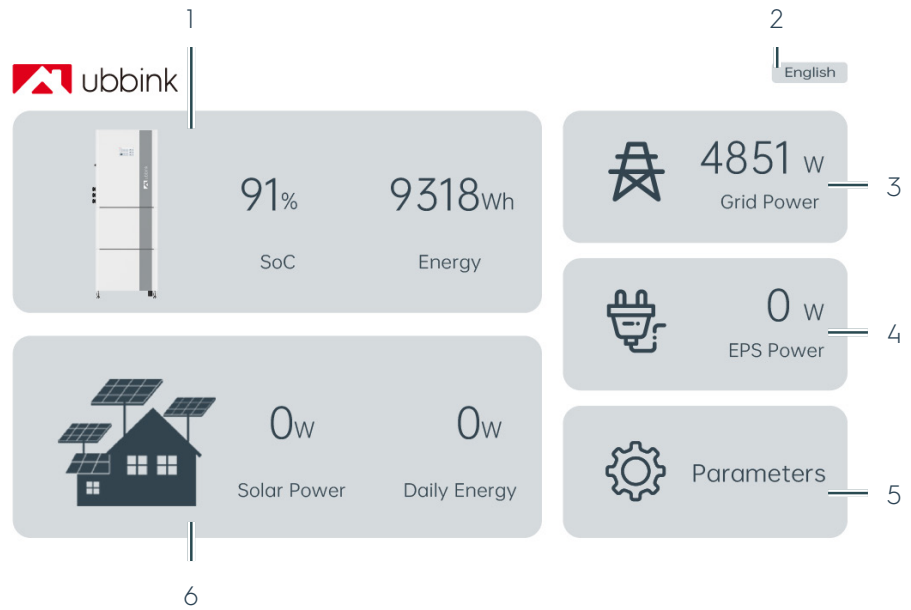

Figure 16 Home (start screen)

Pos.	Designation
1	Battery overview (SoC and capacity)
2	Currently set language
3	Grid power
4	EPS power
5	Parameters, opens the settings
6	Overview of PV system (energy turnover and daily yield)

The start screen provides you with an overview of the solar power generated, the battery capacity and the current consumption.



You can return to the start screen from any subpage via an arrow at the bottom right.

2.6.2 Settings

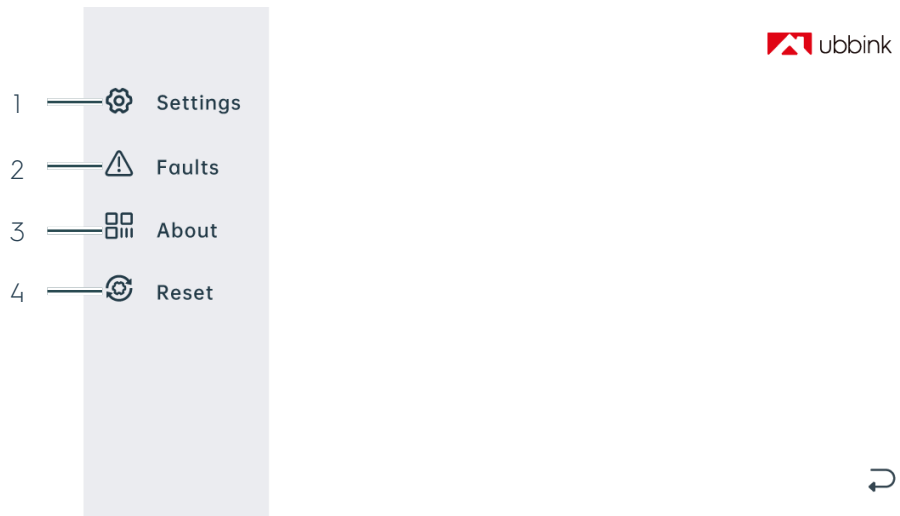

Figure 17 Settings

Pos.	Designation
1	Settings
2	Faults
3	About
4	Reset

Settings

In the **Settings**, you can make operational settings for how the Ubbink Battery Energy Storage System works.

Faults

Faults contains messages with error codes, see chapter "6.2 Troubleshooting" on page 78.

About

About contains the system identification number of the Ubbink Battery Energy Storage System and the QR code with a link to this Operating instructions.

Reset / factory settings

Reset allows you to reset the Ubbink Battery Energy Storage System to the factory settings.

Notice! When resetting, personal settings are lost and cannot be restored.

2.6.3 Display of operating parameters

EPS 1

	V	A	W
L1	Voltage(Vac) 228	Current(A) 0	Power(W) 0
L2	Voltage(Vac) 230	Current(A) 0	Power(W) 0
L3	Voltage(Vac) 232	Current(A) 0	Power(W) 0

Figure 18 Example: Information page for EPS1

On the various subpages you will find detailed information on the individual power sources, the battery and power consumption. You cannot make any settings on these pages.

2.7 Profiles / scenarios



Hint

- ▶ If you activate the **Anti Reverse** function, surplus energy is not fed into the grid.

2.7.1 Self consumption

PV system, grid and battery available

Battery charging and grid feed

Sufficient solar energy, surplus energy for battery charging and into the grid



Figure 19 Sufficient solar energy, surplus energy for battery charging and into the grid

Solar energy is supplied to the connected consumers. If the solar energy is sufficient to supply all connected consumers, additional energy is used to charge the battery. Surplus energy is fed into the grid.

Battery discharging

Solar energy not sufficient, additional energy from the battery



Figure 20 Solar energy not sufficient, additional energy from the battery

Solar energy is supplied to the connected consumers. If the solar energy is not sufficient to supply all connected consumers, additional energy is taken from the battery.

Battery discharging and energy from the grid

Solar energy and battery not sufficient, additional energy from the grid



Figure 21 Solar energy and battery not sufficient, additional energy from the grid

Solar energy is supplied to the connected consumers. If the solar energy and the energy from the battery are not sufficient to supply all connected consumers, additional energy is taken from the grid.

PV system and battery available (disconnected from the grid)

Battery charging

Sufficient solar energy, surplus energy for battery charging



Figure 22 Sufficient solar energy, surplus energy for battery charging

Solar energy is supplied to the connected consumers. If the solar energy is sufficient to supply all connected consumers, additional energy is used to charge the battery.

Battery discharging

Solar energy not sufficient, additional energy from the battery

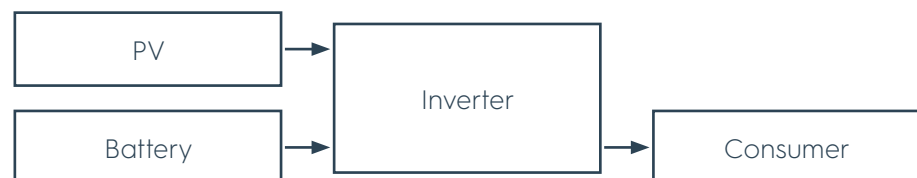

Figure 23 Solar energy not sufficient, additional energy from the battery

Solar energy is supplied to the connected consumers. If the solar energy is not sufficient to supply all connected consumers, additional energy is taken from the battery.

2.7.2 Peak shift

PV system, grid and battery available

Battery charging and grid feed

Sufficient solar energy, surplus energy for consumers and into the grid



Figure 24 Sufficient solar energy, surplus energy for consumers and into the grid

Solar energy is supplied to the battery during the charging process. If the solar energy is sufficient to charge the battery, additional energy is used to supply the connected consumers. Surplus energy is fed into the grid.

Battery charging and energy from the grid

Solar energy not sufficient, additional energy for consumers from the grid



Figure 25 Solar energy not sufficient, additional energy for consumers from the grid

Solar energy is supplied to the battery during the charging process. If the solar energy is not sufficient to charge the battery and supply the connected consumers, additional energy is taken from the grid.

Grid feed

Battery charged, sufficient solar energy, surplus energy and energy from the battery into the grid



Figure 26 Battery charged, sufficient solar energy, surplus energy and energy from the battery into the grid

During the discharging process, solar energy is supplied to the connected consumers. Surplus solar energy and energy from the battery are fed into the grid at the same time.

When neither discharging nor charging the battery, solar energy is supplied to the connected consumers. Surplus energy is fed into the grid.

Battery and grid available (separate from PV system)

Battery charging and energy from the grid

Energy for battery charging from the grid



Figure 27 Energy for battery charging from the grid

During the charging process, energy from the grid is used to recharge the battery and supply the connected consumers.

Battery discharging and grid feed

Energy from the battery sufficient, surplus energy into the grid



Figure 28 Energy from the battery sufficient, surplus energy into the grid

During the discharging process, energy from the battery is supplied to the connected consumers. If the energy is sufficient to supply the connected consumers, surplus energy is fed into the grid.

Battery discharging and energy from the grid

Energy from the battery not sufficient, additional energy from the grid



Figure 29 Energy from the battery not sufficient, additional energy from the grid

During the discharging process, energy from the battery is supplied to the connected consumers. If the energy is not sufficient to supply the connected consumers, additional energy is taken from the grid.

2.7.3 Battery priority

PV system, grid and battery available

Battery charging and grid feed

Sufficient solar energy, surplus energy for consumers and into the grid



Figure 30 Sufficient solar energy, surplus energy for consumers and into the grid

Solar energy is supplied to the battery. If the solar energy is sufficient to charge the battery, additional energy is used to supply the connected consumers. Surplus energy is fed into the grid.

Battery charging and energy from the grid

Solar energy not sufficient, additional energy for consumers from the grid



Figure 31 Solar energy not sufficient, additional energy for consumers from the grid

Solar energy is supplied to the battery. If the solar energy is not sufficient to charge the battery and supply the connected consumers, the consumers are supplied by additional energy from the grid.

Battery and grid available (separate from PV system)

Battery charging and energy from the grid

Energy for battery charging and consumers from the grid



Figure 32 Energy for battery charging and consumers from the grid

Energy from the grid is used to recharge the battery and supply the connected consumers.

3. Transport, storage, unpacking

3.1 Transport



CAUTION

Injuries possible due to falling loads.



- ▷ Two persons are required to transport the packages of the Ubbink Battery Energy Storage System.
- ▷ If necessary, use a suitable means of transport, e.g. a stair trolley or a transport trolley.
- ▷ Secure the Ubbink Battery Energy Storage System to the means of transport.
- ▷ Wear protective gloves and safety shoes.

Number of packages	Contents per package
1	Battery
1	Inverter

Table 16 Packages of the Ubbink Battery Energy Storage System

3.2 Storage

NOTICE

Damage to the battery and shortening of the service life possible due to deep discharge.

- ▷ Charge the battery every 6 months to prevent deep discharging.
- ▷ Damage caused by deep discharging may invalidate the warranty.

Store the Ubbink Battery Energy Storage System in a covered, dry and swept clean indoor area. Follow the information on storage temperature and humidity, see chapter "2.4.1 Ambient conditions" on page 35.

3.3 Unpacking



Hint

- ▷ Keep the original packaging if you need to repack the Ubbink Battery Energy Storage System or want to store it for a longer period of time.

The packaging material consists of plastic, cardboard and wood. Separate the packaging material according to material and recycle it in an environmentally friendly manner.

4. Operation preparation



Instruction video on assembly and installation

4.1 Assembly



WARNING

Danger to life possible due to incorrect assembly.

- ▷ Have the Ubbink Battery Energy Storage System installed and electrically connected by qualified electricians only.
 - ▷ Assemble the Ubbink Battery Energy Storage System with at least two people.
 - ▷ Do not wear watches, rings or other metal objects during installation.
 - ▷ Do **not** place any metal parts, e.g. tools, on the batteries.
 - ▷ Use insulated tools **only**.
 - ▷ Check that all devices, accessories and cables are in perfect condition.
 - ▷ Replace damaged devices, accessories and cables before putting the Ubbink Battery Energy Storage System into operation.
 - ▷ Wear a dust mask.
-

Prerequisite:

- Necessary tools:
 - Impact drill,
 - Open-end spanner size 10,
 - Phillips screwdriver size PH 2,
 - Tape measure,
 - Spirit level,
 - Pencil,
 - Soft padding, e.g. the foam from the original packaging,
 - Rubber mallet,
 - Cutter knife,
 - Vacuum cleaner.

Assemble the Ubbink Battery Energy Storage System:

Prepare the feet and first battery module

1. Place the bottom battery module with the back on soft padding, e.g. the foam from the original packaging.
2. Screw the 4 feet into the underside of the battery module by hand.
3. Tighten the nut on each foot by hand.
4. Remove the cover from the connection on the underside of the battery module.

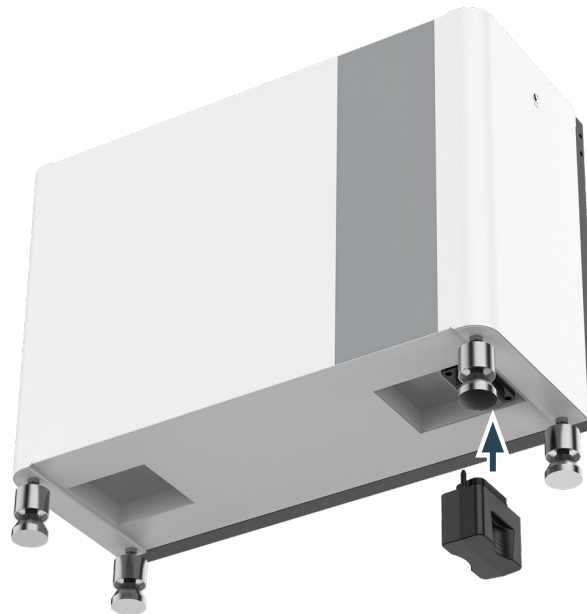

Figure 33 First battery module with feet and short terminal plug

5. Insert the short terminal plug on the underside of the battery module.
6. Place the battery module vertically on the feet.
7. Use the carry handles to transport the battery module to the wall to which the Ubbink Battery Energy Storage System is attached.
8. Check the alignment of the battery module using a spirit level.
9. Level the feet using the lock nuts until the battery module is level:
 - Anti-clockwise: Lift.
 - Clockwise: Lower.
10. Tighten the nuts on the feet using a 10 mm open-end spanner.

Prepare 2nd battery
module

11. Remove the cover from the connection on top of the battery module.
⇒ You have installed the first battery module.
12. Place the second battery module with the back on soft padding, e.g. the foam from the original packaging.
13. Remove the cover from the connection on the underside of the battery module.

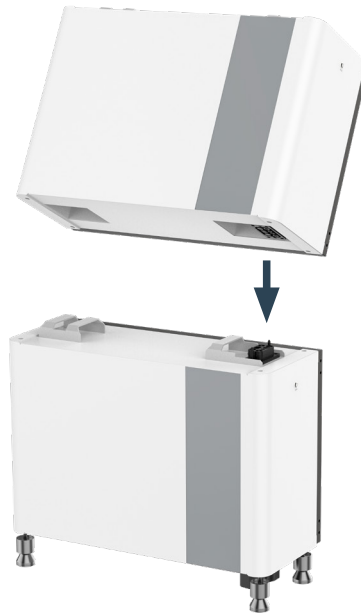

Figure 34 Assembling the second battery module

14. Lift the battery module with two persons using the carry handles and place it on the first battery module.
The two connections must snap into each other.
⇒ You have installed the second battery module.
15. Attach the 2 wall brackets to both sides of the battery modules using the 2 outer M5x12 screws.
16. Use a pencil to mark the 2 drill holes (1 on the left and 1 on the right) for the wall brackets on the wall.
17. Drill 2 holes in the wall using a $\varnothing 6$ mm impact drill.



Figure 35 Assembling the wall bracket

18. Attach the 2 wall brackets to the sides of the battery modules with 4 M5x12 screws each.

19. Tighten one expansion screw in each of the drill holes in the wall to 9 Nm.
- ⇒ You have assembled the battery modules and attached them to the wall.
20. Repeat steps 12 to 19 if your option contains 3 battery modules.
21. Place the inverter with the back on soft padding, e.g. the foam from the original packaging.
22. Remove the cover from the connection on the underside of the inverter.

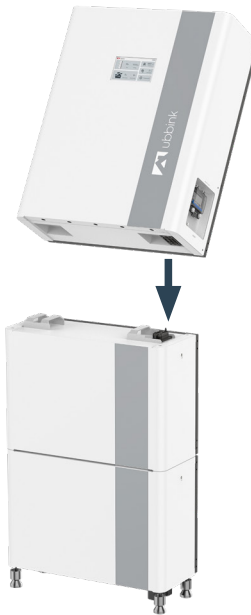

Figure 36 Assembling the inverter on the battery module

23. Lift the inverter with two persons using the carry handles and place it on the top battery module.
The two connections must snap into each other.
24. Attach the 2 wall brackets to both sides of the battery modules and inverter using the 2 outer M5x12 screws.
25. Use a pencil to mark the 2 drill holes (1 on the left and 1 on the right) for the wall brackets on the wall.
26. Drill 2 holes in the wall using a $\varnothing 6$ mm impact drill.



Figure 37 Assembling the wall bracket

27. Attach the 2 wall brackets to the sides of the battery modules with 4 M5x12 screws each.

- 28.** Tighten one expansion screw in each of the drill holes in the wall to 9 Nm.
 - 29.** Attach the 2 wall brackets to the sides of the inverter with the 4 M5x12 screws.
 - 30.** Use a pencil to mark the 2 drill holes (1 on the left and 1 on the right) for the wall brackets on the wall.
 - 31.** Loosen the 4 M5x12 screws and remove the wall brackets from the inverter.
 - 32.** Drill 2 holes in the wall using a $\text{Ø}6$ mm impact drill.
 - 33.** Attach the 2 wall brackets to the sides of the inverter with 4 M5x12 screws each.
 - 34.** Tighten one expansion screw in each of the drill holes in the wall to 9 Nm.
- ✓ You have assembled the inverter and attached it to the wall.

4.2 Electrical connection

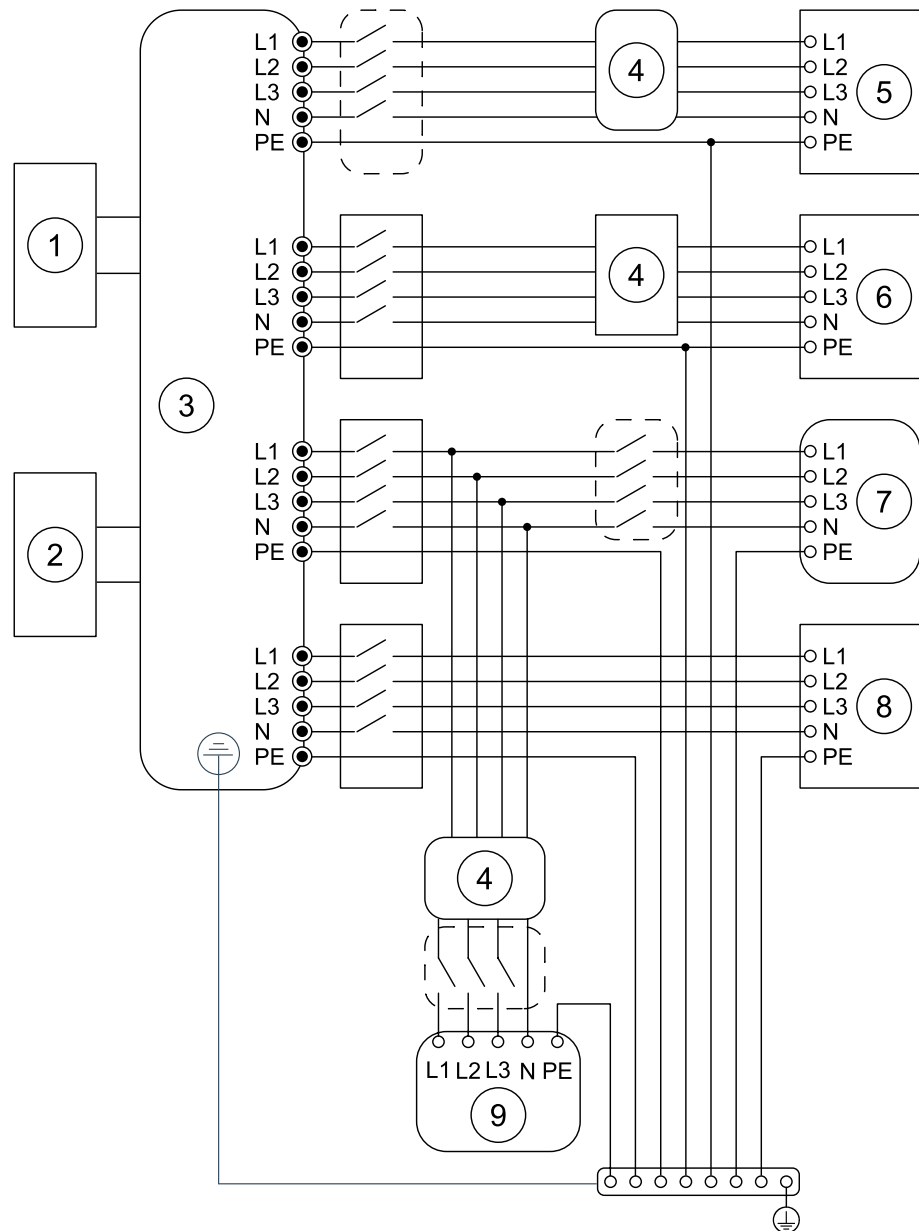

Figure 38 Wiring diagram

Pos.	Designation
1	Battery
2	PV system
3	Inverter
4	RCD (integrated)
5	EPS 1
6	EPS 2
7	Grid
8	Generator
9	Consumer



! WARNING

Danger to life possible due to incorrect electrical connection.

- ▷ Have the Ubbink Battery Energy Storage System electrically connected by qualified electricians only.
- ▷ Do **not** earth the positive and/or negative PV connections.
- ▷ **Never** connect consumers directly to the inverter.
- ▷ Do not wear watches, rings or other metal objects during installation.
- ▷ Do **not** place any metal parts, e.g. tools, on the batteries.
- ▷ Use insulated tools **only**.

Prerequisite:

- The power supply to the grid and PV system is separate.
- The Ubbink Battery Energy Storage System is assembled and attached to the wall.
- Determine the required cable cross section based on the expected loads.
- Necessary tools:
 - Wire stripper,
 - Side cutter,
 - Crimping pliers for pin cable lugs and wire end ferrules,
 - Voltmeter (DC range $\geq 1\ 000\ \text{V DC}$),
 - Cutter knife,
 - Cable ties,
 - Shrink tubing,
 - Hot air gun.

Connect the Ubbink Battery Energy Storage System:

1. Check that the PV switch is switched off.
2. Check that the battery switch is switched off.
3. Measure the voltage of the module field with a voltmeter.
4. Check that the PV positive pole and PV negative pole of the PV string combiner box are connected correctly.
5. Check that the AC resistance between the positive pole and the negative pole of the PV system and earth is within the M Ω range.
6. Remove the rubber cover from the multiple cable gland for PV, EPS and grid.

Recommended cables

7. Select the appropriate cables.

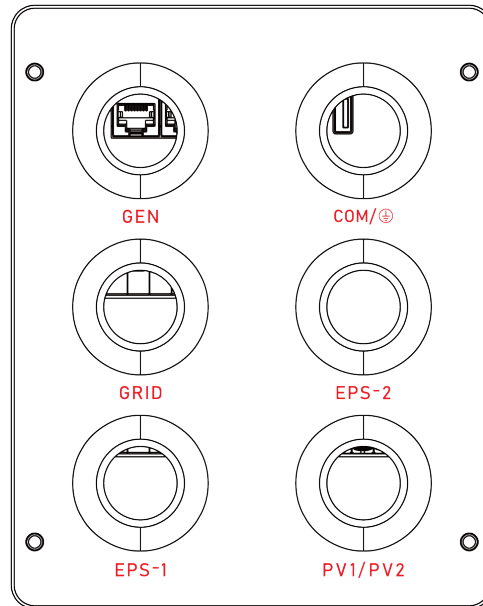

Figure 39 Cable inlet and terminals on the inverter

AC connection	L1	L2	L3	N	PE	
GRID / GEN /	Colour	Brown	Black	Grey	Blue	Green / yellow
EPS-1 / EPS-2	Cross-section [mm ²]	4 - 6	4 - 6	4 - 6	4 - 6	2.5 - 6
	Current [A]	20	20	20	20	< 1

Table 17 AC connection: Recommended cables

DC connection	(+)	(-)	
PV-1 / PV-2	Colour	Blue	Black
	Cross-section [mm ²]	4 - 6	4 - 6
	Current [A]	18	18

Table 18 DC connection: Recommended cables

Earthing connection	Earthing	
COM / ⊕	Colour	Green / yellow
	Cross-section [mm ²]	2.5 - 6
	Current [A]	< 1

Table 19 Earthing connection: Recommended cables

8. Guide the connection cables through the corresponding cable gland according to the definition of the input holes.
9. Strip approx. 10 mm of insulation from the 2 PV connection cables.
10. Guide the 2 PV connection cables into one cable lug each.
11. Crimp the end of the 2 cable lugs using crimping pliers.
12. Connect the positive pole of the PV system to the positive pole of the inverter.
13. Connect the negative pole of the PV system to the negative pole of the inverter.

14. Check that the mains voltage is within the permissible range, see chapter "2.4.3 Inverter data" on page 36.
15. Connect the L1, L2 and L3 grid cables to the same connections on the inverter.
16. Connect the L4 grid cable to the N connection of the inverter.
17. Connect the L5 grid cable to the fixed earth connection of the inverter.
18. Connect the generator according to the wiring diagram.
19. **Ensure that the starting current of the devices connected to EPS does not exceed the maximum limit values.**
20. Connect the L1, L2 and L3 EPS cables to the same connections on the inverter.
21. Connect the L4 EPS cable to the N connection of the inverter.
22. Connect the L5 EPS cable to the earth connection of the inverter.
23. Repeat steps 19 - 21 for a second EPS connection.
24. Remove the cable gland for the communication cables.
25. Remove the rubber cover and the rubber ring from the cable gland.
26. Feed the Ethernet cable through the plastic head and the plastic ring of the cable gland.
27. Push the Ethernet cable through the cut-out gap into the hole in the rubber ring.
28. Screw the plastic head and the plastic ring onto the rubber ring.
29. Screw in the cable gland.
30. Connect the Ethernet cable to the CT connection of the inverter.
31. Install the creeping current protective conductor.
32. Tighten the screw on the creeping current protective conductor.
33. Move the cable inlet up to the housing of the inverter.
34. Tighten 4 M5x12 screws in the cable inlet cover.
35. Tighten the watertight covers of the cable glands by hand.
36. Connect the L1, L2 and L3 bus cables to the L1, L2 and L3 lines of the grid cable one after the other.
The ideal position for the CT clips is directly after the grid supply or energy meter.

Ensure that the arrows on the CT clips points in the direction of the grid supply (energy meter or main switch board):

Colour of the CT cable	Assigned power line
Yellow-black	L1
Light blue-black	L2
Red-black	L3

37. Screw the earthing cable to the wall or floor.
- ✓ You have connected the Ubbink Battery Energy Storage System.

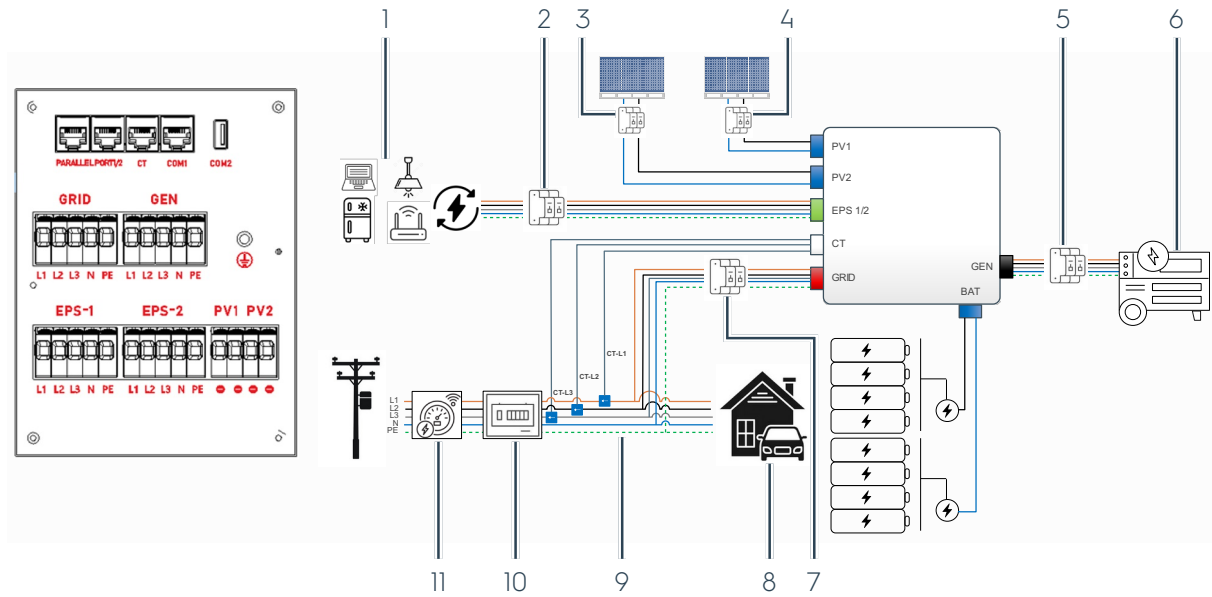

Figure 40 Wiring diagram of the Ubbink Battery Energy Storage System

Pos.	Designation
1	Critical loads Critical EPS loads are limited to the rated power of the inverter
2	EPS circuit breaker (on site)
3	PV2 circuit breaker (on site)
4	PV1 circuit breaker (on site)
5	GEN EPS circuit breaker (on site)
6	Generator (GEN)
7	GRID IN / OUT circuit breaker (on site)
8	In-house consumers
9	CT-L1, CT-L2, CT-L3 - arrow pointing in the direction of the grid Current transformer installed directly after the maintenance switch for the in-house load for recording / measurement
10	Main switch (on site)
11	Intelligent meter (smart meter) - optional accessory

4.3 Checks

4.3.1 Electrical checks

Perform the following electrical checks **before** placing the Ubbink Battery Energy Storage System into operation:

- All cables are labelled according to their function.
- All cables are colour-coded in accordance with local electrical regulations and are marked with the correct current.
- All cables are crimped, secure and insulated.
- All metallic residues from the installation have been removed from the electrical interfaces.
- The safety labels are complete and perfectly legible.
- Animals or humans have **no** access to the electrical cables or circuits.
- The serial battery connector is plugged into the base.
- The sum of the EPS loads does **not** exceed the maximum power of the installed inverter.
- The electrical inputs and outputs of the system are fused for the expected load.
- All safety switches at the inputs and outputs function correctly.
- The system can be electrically isolated for maintenance work.
- The system is electrically earthed.
- Before completion of the work: No problems with insulation.

4.3.2 Mechanical checks

Perform the following mechanical checks:

- The housing has no dents, scratches or damage.
- Tensile test: The battery and the inverter are securely attached to the wall.
- The system is level on the floor.
- The battery is located at least 3 ... 5 cm above the floor.
- The display is fully functional.

4.3.3 Configuration checks

Perform the following configuration checks:

- The EMS is connected correctly.
- The internet connection with the EMS service provider is working.
- The display or EMS service tool do not show any system errors.
- The correct electrical region has been selected.
- The system date and time are set correctly.
- The customer was asked about their preferences for the operating modes.
- The anti-islanding measures are active.

4.3.4 Checks with the end customer

Perform the following checks with the end customer:

- The customer was asked about the expected loads during operation.
- The customer is informed about the system limits.
- The customer knows the safety functions of the system and can operate them correctly.

4.4 Commissioning



WARNING

Danger to life possible due to live parts.

- ▷ Have the Ubbink Battery Energy Storage System commissioned by qualified electricians only.
- ▷ Do not wear watches, rings or other metal objects during commissioning.

4.4.1 Switching on

Prerequisite:

- The Ubbink Battery Energy Storage System is installed and electrically connected.

Switch on the Ubbink Battery Energy Storage System:

1. Switch on the PV input.
 2. Switch on the battery fuse (lever up).
 3. Press the main switch.
- ⇒ The inverter is supplied with current.
 - ⇒ The Ubbink Battery Energy Storage System starts up.
 - ✓ You have switched on the Ubbink Battery Energy Storage System.

4.4.2 Initial commissioning

For initial commissioning of the Ubbink Battery Energy Storage System proceed as follows:

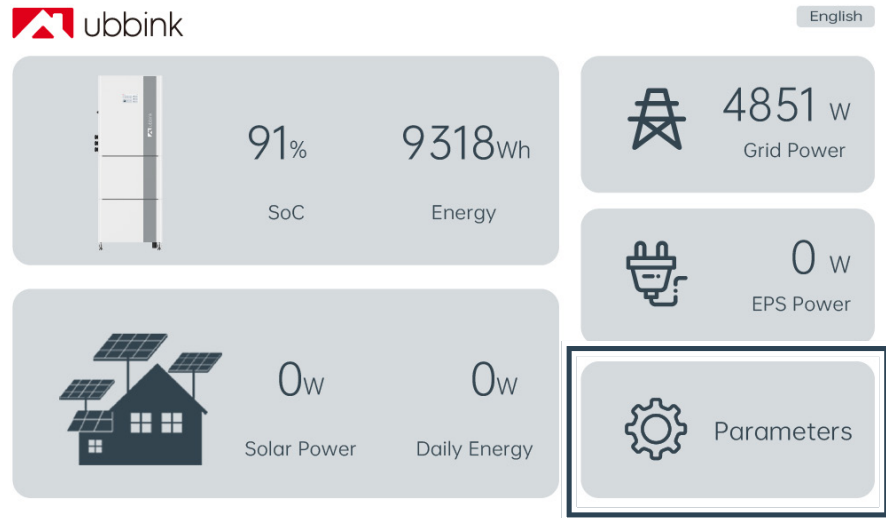

Figure 41 Main menu

1. Select **Parameters** in the main menu to open the menu.

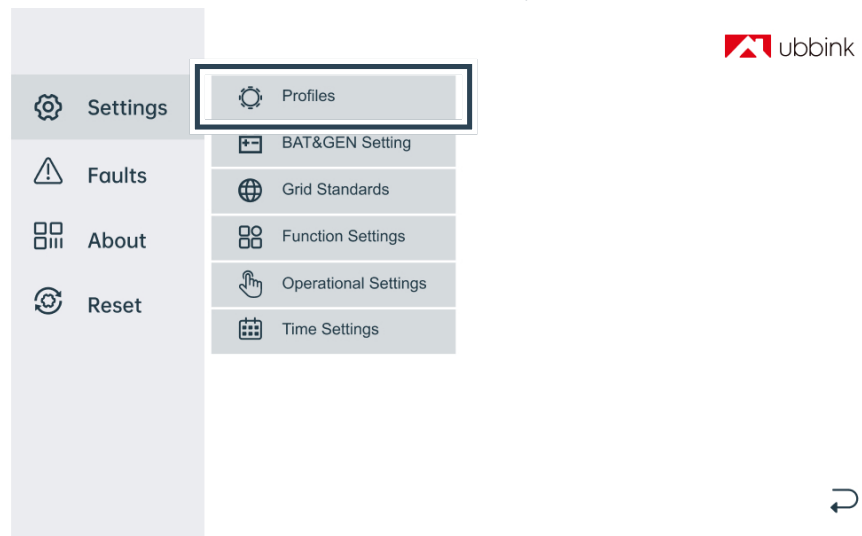

Figure 42 Settings | Profiles

2. Select **Settings | Profiles**. As described in Section 4.4.2, during the initial commissioning, select the Profile "Battery Priority" to charge the batteries to 100% SoC. Once this has been completed, select your preferred Profile. Standard Profile is "Self Consumption".
3. **Charge the batteries to 100% SoC in Battery Priority mode for at least 48 hours before planned use.**

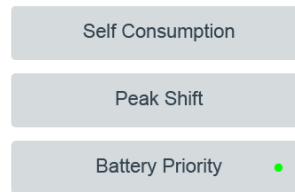

Figure 43 Selecting a profile



Hint

- ▷ Please note that only one profile is active or can be selected at a time.
- ▷ Changes to profiles or setting are permanently stored after **10 minutes**, unless the Ubbink Battery Energy Storage System is reset, or new changes or settings are made.

4. Select the desired profile, see chapter "2.7 Profiles / scenarios" on page 43 :
 - Self Consumption (Standard),
 - Peak Shift,
 - Battery Priority.

5. Touch the arrow at the bottom right to return to the main menu.

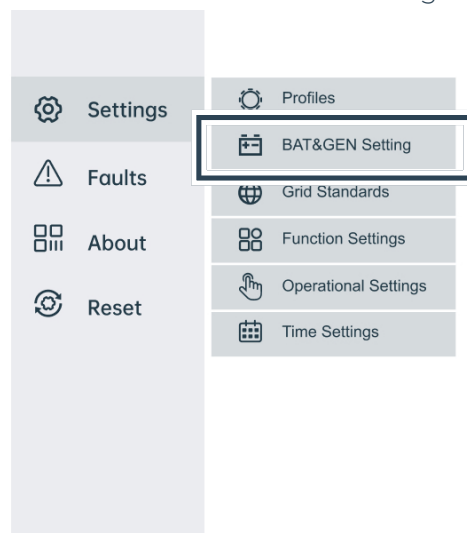

Figure 44 Settings | BAT&GEN Settings

6. Select **Settings** | **BAT&GEN Settings**.

Battery And Generator Settings



Figure 45 Battery settings

7. Specify the lower Discharge of Depth of the battery.
The battery is factory-set to a minimum SoC of 20%, see chapter "1.8.9 Deep discharging" on page 17.
8. Touch **Apply**.
9. Specify the maximum charge current
10. Turn on GEN setting if you wish to connect an external generator.
11. Touch **Apply**.
12. Touch the arrow at the bottom right to return to the main menu.

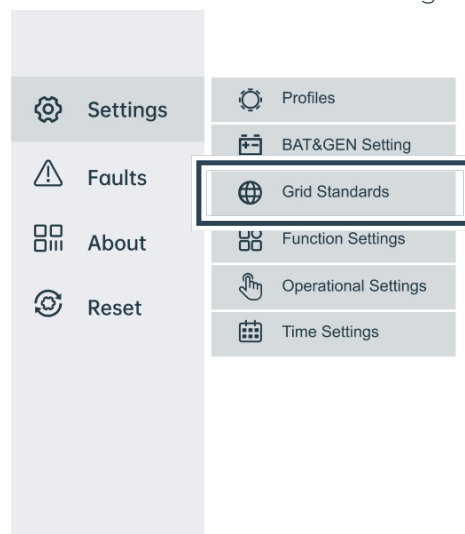

Figure 46 Settings | Grid Standards

13. Select **Settings | Grid Standards**.

Grid Standards

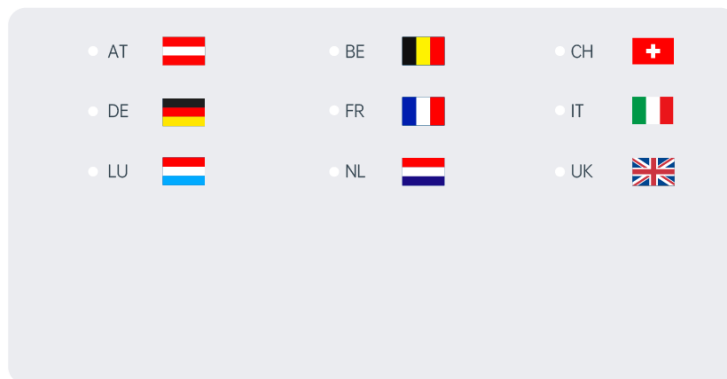

Figure 47 Grid Standards

14. Select your country.

15. Touch the arrow at the bottom right to return to the main menu.

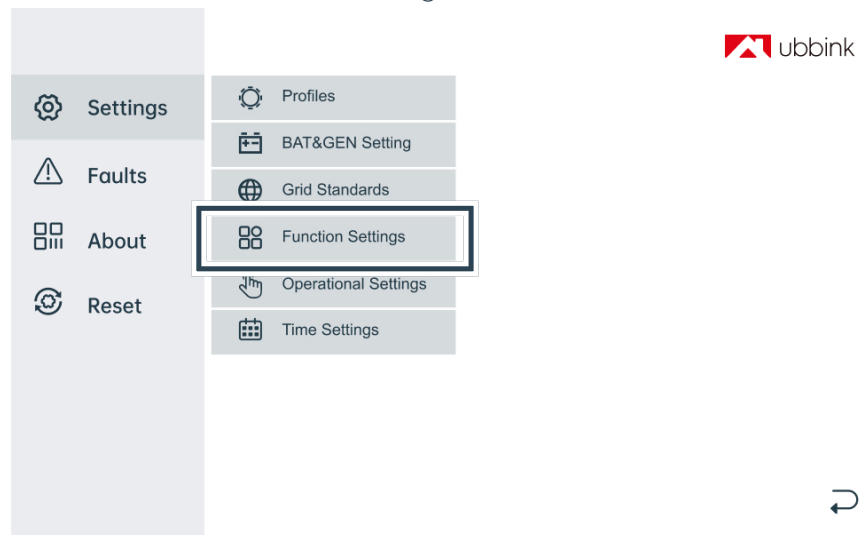

Figure 48 Settings | Function Settings

16. Select **Settings | Function Settings**.

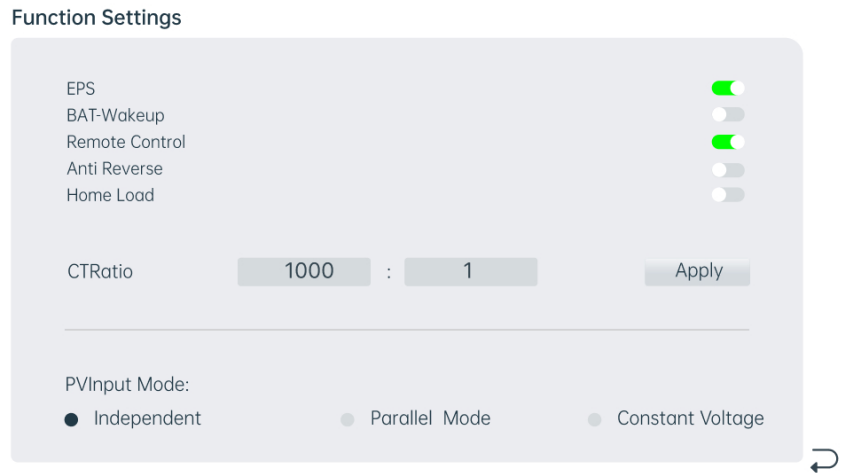

Figure 49 Settings | Function Settings

17. Check the system settings.
18. Touch the arrow at the bottom right to return to the main menu.

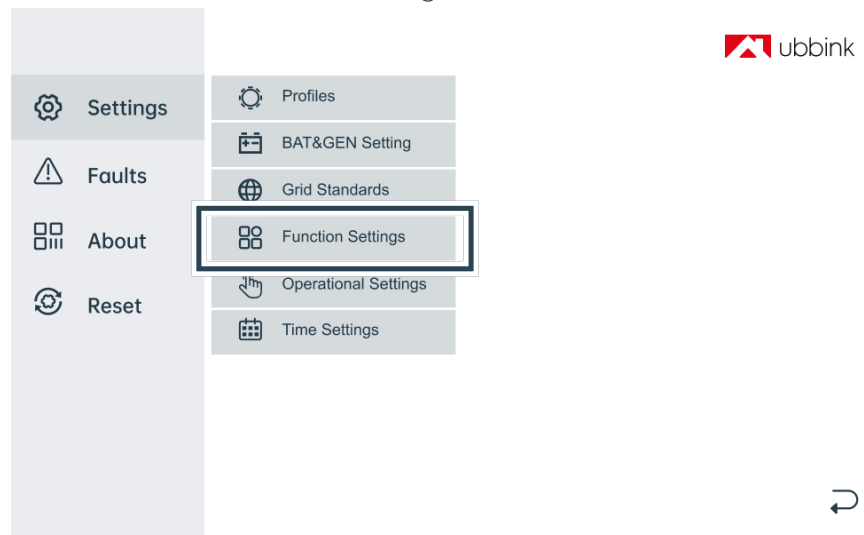

Figure 50 Settings | Function Settings

19. Select **Settings | Function Settings**.

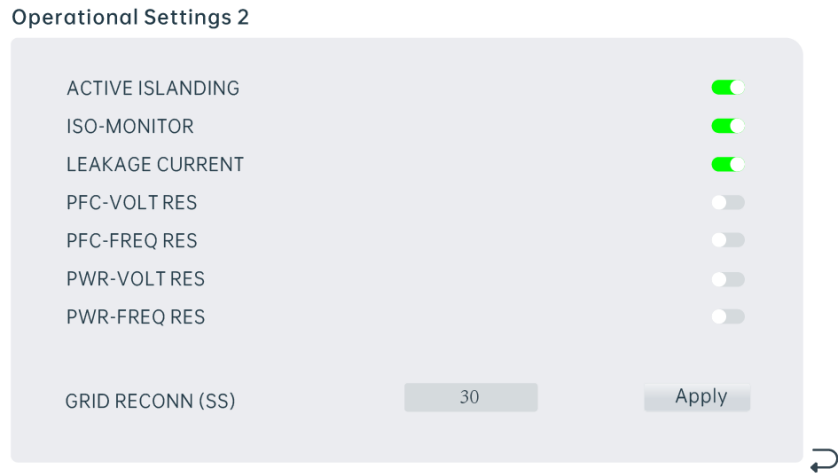

Figure 51 Settings | Operational Settings 2

- 20. Check the system settings.
- 21. Touch the arrow at the bottom right to return to the main menu.

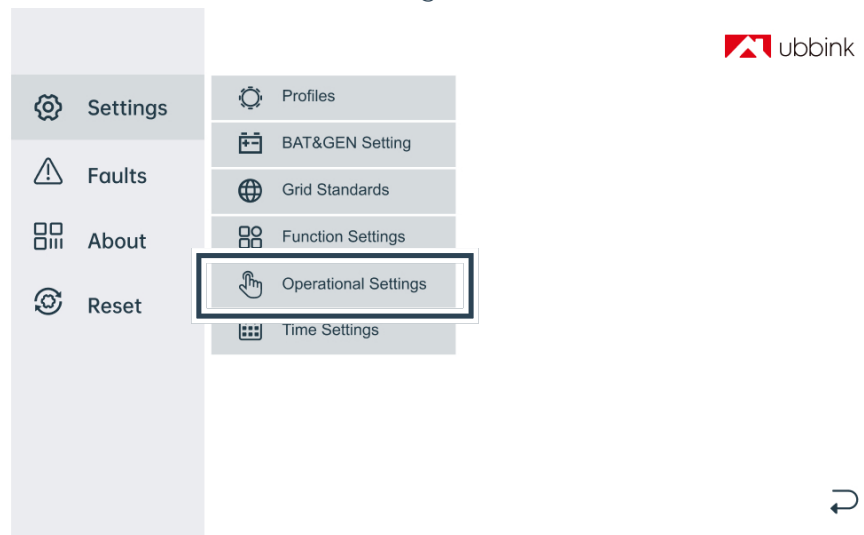

Figure 52 Settings | Operational Settings

- 22. Select **Settings | Operational Settings**.

Operational Settings 1

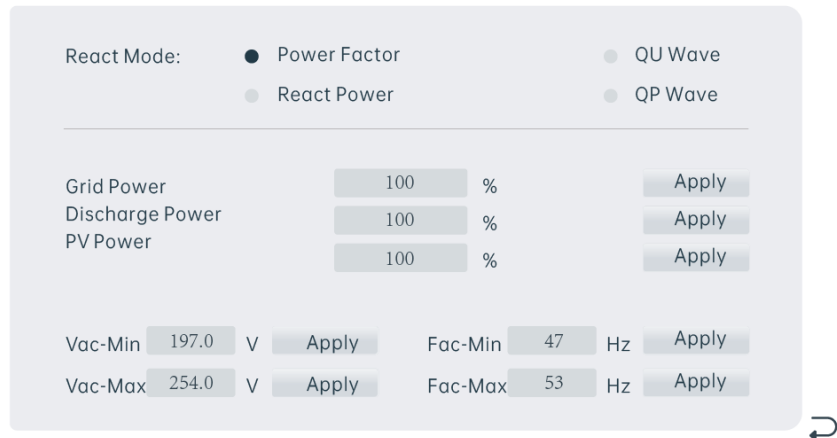

Figure 53 Settings | Operational Settings 1

23. Check the system settings.

24. Touch the arrow at the bottom right to return to the main menu.

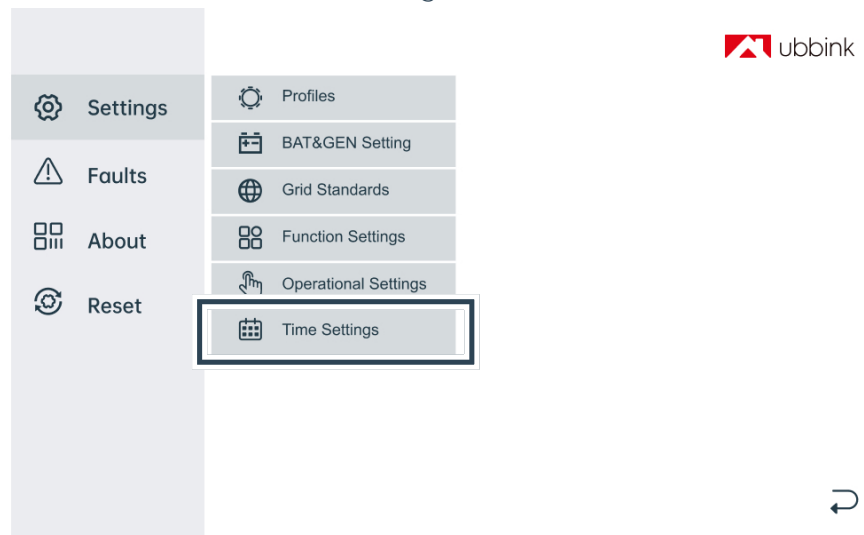

Figure 54 Settings | Time Settings

25. Select **Time Settings** in the main menu.

Time Settings

Date: 25 / 3 / 2024 Apply

Time: 12 : 18 : 53

Week: Mon Tue Wed Thu
 Fri Sat Sun

Figure 55 Time settings

- 26.** Enter the current date and time.
 - 27.** Touch **Apply**.
 - 28.** Touch the arrow at the bottom right to return to the main menu.
- ✓ You have completed the initial commissioning of the Ubbink Battery Energy Storage System.

4.4.3 Setting Peak Shift mode

1. Select the desired profile, see chapter "2.7 Profiles / scenarios" on page 43:
 - Self Consumption,
 - Peak Shift,
 - Battery Priority.

Peak Shift

Time Period	Charge Time (hh:mm)	Discharge Time (hh:mm)
Time Period 1 (Selected)	09:30 - 09:40	10:10 - 10:15
Time Period 2	09:43 - 09:54	10:20 - 10:25
Time Period 3	10:00 - 10:05	10:30 - 10:35

Apply



Figure 56 Example: Settings for the Peak Shift profile

2. Enter the data for the profile.
 3. Touch **Apply**.
 4. Touch the arrow at the bottom right to return to the profile selection.
 5. Repeat steps 2 - 5 for all other profiles.
 6. Touch the arrow at the bottom right to return to the main menu.
- ✓ You have defined the profile.

4.5 Recommissioning

Prerequisite:

- The Ubbink Battery Energy Storage System is installed and electrically connected.

Recommission the Ubbink Battery Energy Storage System:

1. Switch on the PV input.
 2. Switch on the battery fuse (lever up).
 3. Press the main switch.
- ⇒ The inverter is supplied with current.
- ⇒ The Ubbink Battery Energy Storage System starts up.
- ✓ You have recommissioned the Ubbink Battery Energy Storage System.

4.6 EMS integration and activation

4.6.1 Before installation

Register as an installer for the Voltara Installer Centre:

1. Open the page installer.voltara.ch in a browser.
 2. Click on **Register**.
 3. Complete the input mask.
 4. Confirm the terms of use.
 5. Click on **Send**.
- ✓ You have registered as an installer for the Voltara Installer Centre.

4.6.2 During installation: Connect the EMS to the Ubbink Battery Energy Storage System

Assemble the EMS:

1. Take the EMS and all accessories from the packaging.

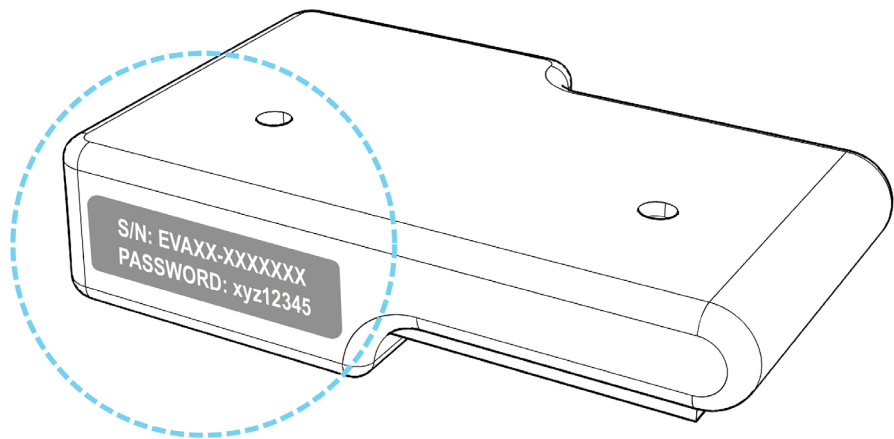

Figure 57 Nameplate on the EMS (example)

2. Check the nameplate and make note of the serial number and password of the gateway.
You will need this to log in to the EMS portal.

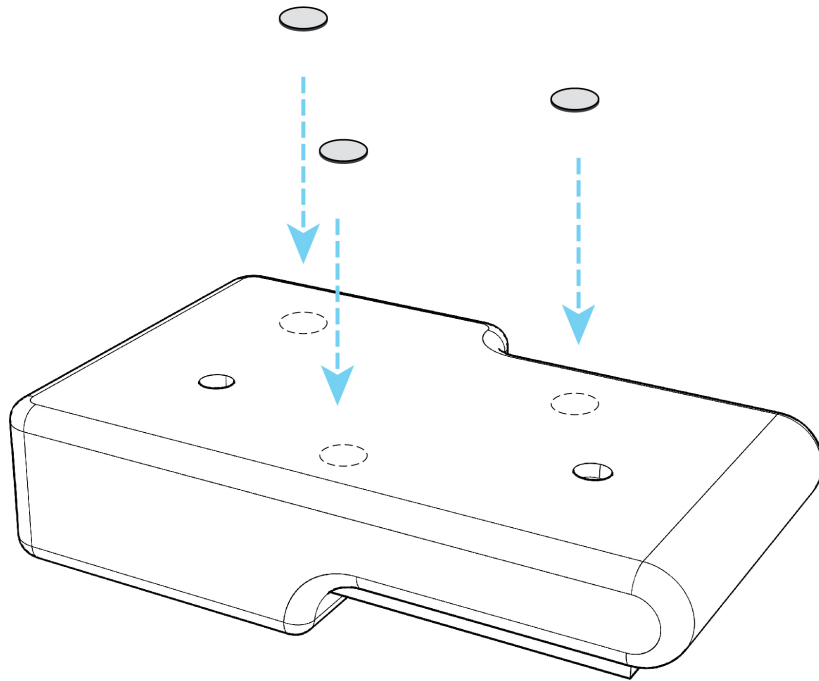

Figure 58 Attachment via magnets

3. Assemble the EMS with the 3 magnets on the inverter.
4. Connect the EMS to the inverter using the RS-485 cable.
5. Connect the EMS to the router via the Ethernet cable.

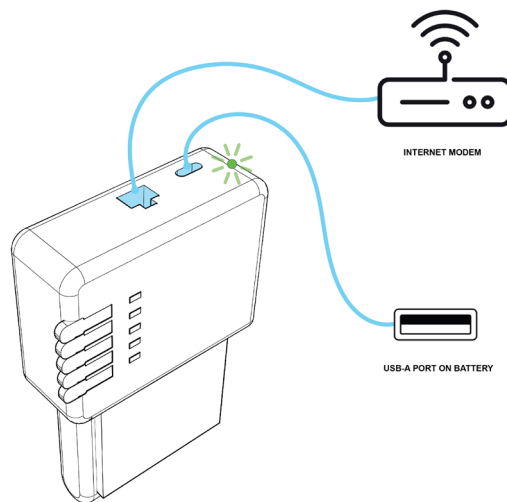

Figure 59 Connecting the EMS to the power supply

6. Connect the EMS to the USB-A port of the inverter using the USB-C cable.



Hint

- ▷ If the 5 status LEDs glow continuously in turquoise after installation, a software update is being carried out.
- ▷ Do **not** disconnect the EMS from the power supply.

7. As soon as the LED indicator light lights up in green, the EMS is operational.

✓ You have assembled the EMS

4.6.3 Connect the EMS to the home network via Wi-Fi (not recommended)

Prerequisite:

- EMS is connected to the home network via Ethernet.
- EMS is switched on.

Necessary tools:

- Laptop or smartphone

Connect the EMS to the home network via Wi-Fi:

1. Enter in the address bar of your browser.
 - Windows: `http://energymanager/`,
 - Linux, Mac OS, iOS: `http://energymanager.local/` or
 - IP address of the gateway. For MAC-ETH, MAC-WiFi and MAC-BT addresses, please refer to the information printed on the EMS packaging carton.

⇒ The user interface of the gateway is displayed.



Hint

- ▷ If no connection is established, try the process in a private window of the browser or in another browser.
-

2. Open the **system settings**.
 3. Switch to the **Network settings** menu.
 4. Enter the data for the Wi-Fi connection in the **Wi-Fi** tab.
 5. Disconnect the EMS from the router by unplugging the Ethernet cable.
 6. Restart the gateway if necessary.
- ✓ You have connected the EMS to the home network via Wi-Fi.

4.6.4 During installation: Connecting devices to the EMS

Prerequisite:

- The Ubbink Battery Energy Storage System has been commissioned.
- The Ubbink Battery Energy Storage System is connected to the EMS via RS485.
- EMS is connected to the home network via Ethernet or Wi-Fi.
- EMS is switched on.

Necessary tools:

- Laptop or smartphone

Connect the EMS to the inverter:

1. Enter in the address bar of your browser.
 - Windows: <http://energymanager/>,
 - Linux, Mac OS, iOS: <http://energymanager.local/> or
 - IP address of the gateway. For MAC-ETH, MAC-WiFi and MAC-BT addresses, please refer to the information printed on the EMS packaging carton.

⇒ The user interface of the gateway is displayed.

Hint

- ▷ If no connection is established, try the process in a private window of the browser or in another browser.



-
2. Click on **Smart Setup**.

⇒ The login screen is displayed.

3. Enter the password of the gateway to log in.
You will find the password on the nameplate of the EMS.
4. Select the **Ubbink hybrid inverter** option from the search configuration.
5. Select “/dev/RS485-1” from the RS-485 PORT NAME drop down menu.
6. Adjust other device-specific settings if necessary.
7. Select all connected devices from the search configuration one after the other.

Hint

- ▷ For some devices, the setup wizard prompts you to enter further details, e.g. interfaces, IP addresses, host names, etc., before you can add the device to the search.



8. When you have added all devices to the search, click **Search and install devices**.
 9. Follow the setup wizard to complete the setup of the energy system.
 10. Invite the customer to the "Voltara Home" app.
- ✓ You have connected the EMS to the inverter.



Hint

- ▷ When registering for "Voltara Home", the customer assigns remote access rights for installers and first-level support from the manufacturer.

If the inverter is not found:

1. Check whether the inverter is properly connected.
2. Check the connection cable of the inverter for a cable break.
3. Make sure that the connection cable has not been laid together with cable bundles with high current loads.
4. Correct connection errors and replace damaged cables.
5. If the fault persists, contact Ubbink Customer Support.

If the inverter is found but does not send any or no plausible values:

1. Check that the inverter is connected to the RS485 interface of the gateway.
2. If the fault persists, contact Ubbink Customer Support.

4.6.5 After the installation: Using the Voltara Installer Centre as an installer

You can access the Voltara Installer Centre via installer.voltara.ch.

After the first login, the start screen shows the main menu **Customers**. Upon first log-in, the customer list is empty.

Add customers

Add a customer:

1. In the **Customers** tab, select the **Add existing customer** option.
 2. Enter the **Gateway serial number (Energy Manager)** and the **password**.
 3. Press **Search customers**.
 4. Click on **Request remote maintenance access from customers**.
- ⇒ The customer receives an email with a link to authorise monitoring and remote maintenance.
- ⇒ Once the customer has confirmed, they will be added to your customer list.
- ✓ You have added the customer.

View customer status
or device status

You can view the customer status and device status in the **Status** column on the **Customers** tab. There are three statuses:

- OK: All devices are working properly.
- ERROR: At least one of the customer's devices has a fault.
- OFFLINE: At least one of the customer's devices is not connected to the Internet.



Hint

- ▷ In case of a malfunction, the system displays the status of the most serious fault and the number of faulty devices.
- ▷ To identify and localise problems, investigate devices with ERROR or OFFLINE status and contact the customer for additional information if necessary.

View the customer status or the device status:

1. Enter the customer's name, user ID, postcode, city or country in the search mask.
⇒ The search results are displayed.
2. Click on the respective customer status in the **Status** column to view devices that have the status ERROR or OFFLINE.
3. Check the status of the devices by clicking on the individual devices.
4. You can view the current status of the device in the "Status" section:
5. For the EMS:
 - OK: The connection between the Energy Manager and the Internet is established.
 - ERROR: The connection between the Energy Manager and the Internet is established. At least one device has no connection.
 - OFFLINE: The connection between the Energy Manager and the Internet is interrupted.
 - Under **Last online** you can see when the EMS last sent data to the cloud.
6. For the connected devices:
 - OK: The device is functioning.
 - ERROR: The device has a fault.
 - OFFLINE: The device has no connection to the EMS.

EMS

Connected devices

✓ You have viewed the customer status or the device status.

Access a customer
application

Access a customer application:

1. Select the **Customers** tab and search for the desired customer.
 2. In the **Actions** column, select the option **Apps**.
 3. Click on the app you wish to use.
- ✓ You have accessed the customer application.

5. Operation

5.1 Normal operation

No operation by the user is required during normal operation.

5.2 Remote Control

You can control the Ubbink Battery Energy Storage System remotely via the "Voltara Home" app.

6. Malfunctions, messages and faults

6.1 Procedure in case of malfunctions



DANGER

Danger to life due to electricity hazard.

- ▷ Have work on the Ubbink Battery Energy Storage System performed by qualified electricians **only**.
- ▷ Work on the Ubbink Battery Energy Storage System with insulated tools **only**.
- ▷ **Never** dismantle parts of the Ubbink Battery Energy Storage System unless it is specifically described in this Operating instructions.
- ▷ **Never** touch the poles of the PV connection device.
- ▷ Do **not** operate any live components or cables if they are disconnected from the Ubbink Battery Energy Storage System.
- ▷ **Always** wait at least 5 minutes after switching off the Ubbink Battery Energy Storage System **before** disconnecting or connecting cables or connections.
- ▷ Use a multimeter to check that the link voltage capacitors are fully discharged **before** disconnecting the DC connection, the battery and the mains coupler or opening the Ubbink Battery Energy Storage System.

Always correct malfunctions:

1. Make sure that there is no danger to persons or property. If danger is imminent, switch off the Ubbink Battery Energy Storage System and disconnect the power supply.
 2. Determine the cause of the malfunction using the fault table.
 3. Follow the instructions in the fault table.
 4. Contact Ubbink Customer Support if necessary.
- ✓ You have corrected the malfunction.

6.2 Troubleshooting

Message	Date	Description	Solution
DischgOverCur	00	Overvoltage during battery discharging	<p>Wait 1 minute while the inverter restarts.</p> <p>Check that the load is within the permissible values, see chapter "2.4.3 Inverter data" on page 36.</p> <ol style="list-style-type: none"> 1. Switch off all appliances and disconnect the power supply. 2. Disconnect the load. 3. Connect the load. <p>⇒ The devices are restarted.</p> <ol style="list-style-type: none"> 4. Check whether the fault has been rectified. 5. If the fault persists, contact Ubbink Customer Support.
Over load	01	Load is greater than the available power (PV system, battery)	<p>Check that the load is within the permissible values, see chapter "2.4.1 Ambient conditions" on page 35.</p> <ol style="list-style-type: none"> 1. Switch off all appliances and disconnect the power supply. 2. Disconnect the load. 3. Connect the load. <p>⇒ The devices are restarted.</p> <ol style="list-style-type: none"> 4. Check whether the load is short-circuited or whether the fault has been rectified. 5. If the fault persists, contact Ubbink Customer Support.
BatDisconnect	02	Battery disconnected or no battery voltage detected	<p>Check that the battery is connected.</p> <p>Check whether the circuit for the battery connection is interrupted. Reset the main switch at the inverter (Picture 1, Pos. 1)</p> <p>If the fault persists, contact Ubbink Customer Support.</p>
Bat Under Vol	03	Battery undervoltage	<ol style="list-style-type: none"> 1. Check the system settings. 2. Disconnect the power supply to restart the devices. 3. If the fault persists, contact Ubbink Customer Support. <ol style="list-style-type: none"> 1. Check whether the grid is without power. 2. Wait until the grid has power again. <p>⇒ The inverter charges the battery automatically.</p> <ol style="list-style-type: none"> 3. If the fault persists, contact Ubbink Customer Support.

Message	Date	Description	Solution
Bat Low capacity	04	Battery capacity low	The battery has low energy (SoC = 0%).
Bat Over Vol	05	Battery voltage is greater than the maximum voltage of the inverter	<ol style="list-style-type: none"> 1. Check the system settings. 2. Disconnect the power supply to restart the devices. 3. If the fault persists, contact Ubbink Customer Support.
Grid low vol	06	Grid voltage is abnormal	<p>Check whether the grid is abnormal. Wait until the grid normalises. If the fault persists, contact network operator if necessary</p> <ol style="list-style-type: none"> 1. Restart the inverter. 2. Wait until the functions have normalised. 3. If the fault persists, contact Ubbink Customer Support.
Grid over vol	07		
Grid low freq	08	Grid frequency is abnormal	<p>Check whether the grid is abnormal.</p> <ol style="list-style-type: none"> 1. Restart the inverter. 2. Wait until the functions have normalised. 3. If the fault persists, contact Ubbink Customer Support.
Grid overFreq	09		
Gfci over	10	Internal RCD of the inverter tripped	<p>Check the PV string for direct or indirect earthing phenomena.</p> <p>Check the peripheral devices of the Ubbink Battery Energy Storage System for leak current.</p> <p>If the fault persists, contact Ubbink Customer Support.</p>
Bus under vol	13	Bus voltage is too low	<p>Check that the input mode settings are correct.</p> <ol style="list-style-type: none"> 1. Restart the inverter. 2. Wait until the functions have normalised. 3. If the fault persists, contact Ubbink Customer Support.
Bus over vol	14	Bus voltage is too high	<p>Check that the input mode settings are correct.</p> <ol style="list-style-type: none"> 1. Restart the inverter. 2. Wait until the functions have normalised. 3. If the fault persists, contact Ubbink Customer Support.
Inv over cur	15	Current of the inverter is too high	<ol style="list-style-type: none"> 1. Restart the inverter. 2. Wait until the functions have normalised. 3. If the fault persists, contact Ubbink Customer Support.

Message	Date	Description	Solution
Chg over cur	16	Battery charge current is higher than the maximum voltage of the inverter	<ol style="list-style-type: none"> 1. Restart the inverter. 2. Wait until the functions have normalised. 3. If the fault persists, contact Ubbink Customer Support.
Bus vol osc	17	Unstable bus voltage	<p>Check that the input and output mode settings are correct.</p> <ol style="list-style-type: none"> 1. Restart the inverter. 2. Wait until the functions have normalised. 3. If the fault persists, contact Ubbink Customer Support.
Inv under vol	18		<ol style="list-style-type: none"> 1. Check the inverter voltage. 2. Restart the inverter.
Inv over vol	19	Inverter voltage is abnormal	<ol style="list-style-type: none"> 3. Wait until the functions have normalised. 4. If the fault persists, contact Ubbink Customer Support.
InvFreqAbnor	20	Frequency of the inverter is abnormal	<ol style="list-style-type: none"> 1. Check the frequency of the inverter. 2. Restart the inverter. 3. Wait until the functions have normalised. 4. If the fault persists, contact Ubbink Customer Support.
igbt temp high	21	Temperature of the inverter is too high	<ol style="list-style-type: none"> 1. Switch off the Ubbink Battery Energy Storage System completely. 2. Wait 1 hour. 3. Check that the ambient temperatures and conditions are permissible, see chapter "2.4.1 Ambient conditions" on page 35. 4. Switch on the Ubbink Battery Energy Storage System. 5. If the fault persists, contact Ubbink Customer Support.
Bat over temp	23	Battery temperature is too high	<p>Check that the ambient temperature around the Ubbink Battery Energy Storage System complies with the permissible values, see chapter "2.4.1 Ambient conditions" on page 35.</p>
Bat under temp	24	Battery temperature is too low	<p>Check that the ambient temperature around the Ubbink Battery Energy Storage System complies with the permissible values, see chapter "2.4.1 Ambient conditions" on page 35.</p>

Message	Date	Description	Solution
BMS comm.fail	27	Communication between battery and inverter is faulty	Check the connection cables and the cable sequence.
Grid Phase err	30	Grid phase error	Check the wiring to the grid.
Arc Fault	31	Arc fault on the PV system	<ol style="list-style-type: none"> 1. Check the PV modules and cables. 2. If the fault persists, contact Ubbink Customer Support.
bus soft fail	32	Inverter may be damaged	1. Restart the inverter.
inv soft fail	33		2. Wait until the functions have normalised.
bus short	34		3. If the fault persists, contact Ubbink Customer Support.
inv short	35		
PV is low	37	PV is too low	<ol style="list-style-type: none"> 1. Check whether the PE cable is connected to the inverter and connected to earth. 2. If the fault persists, contact Ubbink Customer Support.
Bus Relay Fault	38	Inverter may be damaged	<ol style="list-style-type: none"> 1. Restart the inverter. 2. Wait until the functions have normalised. 3. If the fault persists, contact Ubbink Customer Support.
Grid Relay Fault	39		
EPS rly fault	40		
Gfci fault	41		
Selftest fail	44		
System fault	45		
Current DCover	46		
Voltage DCover	47		

Table 20 Fault table

7. Servicing and maintenance

7.1 Maintenance guidelines for battery modules

The Ubbink Battery Energy Storage System is maintenance-free if it is operated within the specifications. A general inspection can be performed in accordance with local regulations or as part of a service contract. Please contact Ubbink Customer Service for more information.

To ensure reliable and safe operation, Ubbink International recommends to:

- Have a calibration and inspection performed annually and to
- Have the entire system inspected annually in as per DGUV regulation 3 (BGV A3) and DIN VDE 0113.

7.1.1 Avoiding deep discharging

Switch off the battery module if it will not be used for a longer period of time in order to prevent the battery module from discharging completely.

You are obliged to use appropriate operating procedures to prevent deep discharging of the battery module.

Ubbink International has implemented extensive hardware and software functions to prevent the battery module from going into deep discharging mode.

If a battery module enters the deep discharging protection state, this is regarded as "misuse" by Ubbink International. The warranty is void if this happens again.

A chargeable service call is required to restore the battery module to normal operation.

For information on winter storage or long-term storage, see chapter "3.2 Storage" on page 48.

7.1.2 Cycle life

A charge cycle is a complete charge and discharge of the battery module. Rechargeable battery modules have a limited service life and gradually lose their capacity.

This loss of capacity (ageing) is irreversible, as several lithium-ion atoms remain permanently trapped in the anode during each cycle. As the battery module loses capacity, the duration of the power supply decreases (runtime/capacity).

The battery module discharges slowly (self-discharge 1 ... 3% per month / when inactive), even if it is not in use or is stored.

7.2 Repair and replacement of parts

If the Ubbink Battery Energy Storage System needs to be repaired, please contact Customer Support: Service@Ubbink.com

For shipping, please note that the battery module may **only** be transported in the original packaging or a newly delivered Ubbink return packaging as per the UN38.3 dangerous goods transport requirements.

7.2.1 Transport packaging



DANGER

Danger of chemical burns due to leaking battery module.

- ▷ **Never** send badly damaged battery modules.
- ▷ Avoid skin and eye contact with any leaking liquid from a leaking battery module.
- ▷ In case of contact with leaking liquid, rinse the affected area with plenty of water and consult a doctor immediately.

You can recognise a damaged battery module e.g. by the following:

- A damaged or significantly deformed housing,
- The battery module heating up when switched off.

Only use the original packaging or Ubbink return packaging to return the battery module. It has the quality and all the labelling required for the return shipment.



Hint

- ▷ Contact Ubbink Customer Support for instructions on how to return the product correctly.
- ▷ If the hazardous goods labelling on the original packaging is not clearly legible, you will receive a Ubbink return packaging via Customer Support.

7.3 Exchange of battery modules

To swap battery modules in an existing system or to add new battery modules after installation, refer to Table 21.

Pre-Installed Capacity	10 kWh	15 kWh	20 kWh	25 kWh
Max after commissioning	≤24 months	≤24 months	≤24 months	≤24 months
Maximum Cycles	800x	800x	800x	800x
Battery State of Health	> 90 %	> 90 %	> 90 %	> 90 %

Pre-Installed Capacity	10 kWh	15 kWh	20 kWh	25 kWh
Charged Total	<8.000 kWh	<12.000 kWh	<16.000 kWh	<20.000 kWh

Table 21 Requirements for battery replacement

8. Decommissioning, dismantling, disposal

8.1 Decommissioning

Decommission the Ubbink Battery Energy Storage System:

1. Press the main switch.
 2. Switch off the battery fuse (lever down).
 3. Switch off the PV input.
- ⇒ The Ubbink Battery Energy Storage System shuts down.
 - ⇒ The inverter is no longer supplied with current.
 - ✓ You have decommissioned the Ubbink Battery Energy Storage System.

8.2 Insulating electrically



WARNING

Danger to life possible due to electricity hazard.

- ▷ Have the Ubbink Battery Energy Storage System electrically insulated by qualified electricians only.
 - ▷ **Always** wait at least 5 minutes after switching off the Ubbink Battery Energy Storage System **before** disconnecting or connecting cables or connections.
 - ▷ Use a multimeter to check that the link voltage capacitors are fully discharged **before** disconnecting the DC connection, the battery and the mains coupler or opening the Ubbink Battery Energy Storage System. **Never** touch the poles of the PV connection device.
 - ▷ Do not wear watches, rings or other metal objects during installation.
 - ▷ Do **not** place any metal parts, e.g. tools, on the batteries.
 - ▷ Use insulated tools **only**.
-

Prerequisite:

- The power supply to the grid and PV system is separate.
- Necessary tools:
 - Voltmeter (DC range $\geq 1\,000\text{ V DC}$),
 - Cutter knife to cut cable ties if necessary.

Insulate the Ubbink Battery Energy Storage System:

- 1.** Check that the PV switch is switched off.
 - 2.** Check that the battery switch is switched off.
 - 3.** Measure the voltage of the module field with a voltmeter.
 - 4.** Disconnect the EMS from the router.
 - 5.** Loosen the cable glands at the cable inlet.
 - 6.** Disconnect the earthing cable from the wall or floor.
 - 7.** Disconnect the L1, L2 and L3 bus cables from the L1, L2 and L3 lines of the grid cable one after the other.
 - 8.** Unscrew the 4 M5x12 screws from the cable inlet cover on the Ubbink Battery Energy Storage System.
 - 9.** Detach the cable inlet from the housing of the inverter.
 - 10.** Loosen the screw on the creeping current protective conductor and disconnect it from the inverter.
 - 11.** Disconnect the Ethernet cable from the CT connection of the inverter.
 - 12.** Unscrew the cable gland of the CT connection from the cable inlet.
 - 13.** Remove the cable gland for the communication cables.
 - 14.** Remove the rubber cover and the rubber ring from the cable gland.
 - 15.** Unscrew the plastic head and the plastic ring from the rubber ring.
 - 16.** Pull the Ethernet cable out of the hole in the rubber ring and through the gap.
 - 17.** Disconnect the L5, L4, L3, L2 and L1 EPS cables from the inverter connections.
 - 18.** Disconnect the generator from the inverter.
 - 19.** Disconnect the L5, L4, L3, L2 and L1 grid cables from the inverter connections.
 - 20.** Disconnect the negative pole of the PV system from the inverter.
 - 21.** Disconnect the positive pole of the PV system from the inverter.
 - 22.** Pull the PV connection cables out of the cable gland of the cable inlet.
- ✓ You have insulated the Ubbink Battery Energy Storage System.

8.3 Dismantling



WARNING

Danger to life due to incorrect dismantling.

- ▷ Have the Ubbink Battery Energy Storage System dismantled by qualified electricians only.
- ▷ Dismantle the Ubbink Battery Energy Storage System with at least two people.
- ▷ Do not wear watches, rings or other metal objects during installation.
- ▷ Do **not** place any metal parts, e.g. tools, on the batteries.
- ▷ Use insulated tools **only**.
- ▷ Wear a dust mask.

Prerequisite:

- The Ubbink Battery Energy Storage System is electrically insulated.
- Necessary tools:
 - Open-end spanner size 10,
 - Phillips screwdriver size PH 2,
 - Soft padding, e.g. the foam from the original packaging,
 - Rubber mallet,
 - Cutter knife,
 - Vacuum cleaner.

Dismantle the Ubbink Battery Energy Storage System:

1. Disconnect the EMS from the power-supply unit.
 2. Remove the EMS from the inverter.
 3. Loosen 1 expansion screw each from the wall and the 4 wall brackets of the inverter.
 4. Loosen the 12 M5x12 screws and remove the 4 wall brackets from the inverter and the battery module.
 5. Lift the inverter with two persons using the carry handles and lift it from the top battery module.
 6. Place the inverter with the back on soft padding, e.g. the foam from the original packaging.
 7. Place the cover on the connection on the underside of the inverter.
- ⇒ You have dismantled the inverter.
8. Loosen 1 expansion screw each from the wall and the 2 wall brackets of the battery module.
 9. Loosen the 8 M5x12 screws and remove the 2 wall brackets from the battery module.
 10. Lift the battery module with two persons using the carry handles and lift it from the lower battery module.
 11. Place the upper battery module with the back on soft padding, e.g. the foam from the original packaging.

12. Place the cover on the connection on the underside of the battery module.
- ⇒ You have dismantled the first battery module.
13. Repeat steps 8 - 12 if your option contains 3 battery modules.
14. Place the lower battery module with the back on soft padding, e.g. the foam from the original packaging.
15. Remove the short terminal plug on the underside of the battery module.
16. Place the cover on the connection on the underside of the battery module.
17. Loosen the 4 feet from the underside of the battery module.
- ✓ You have dismantled the Ubbink Battery Energy Storage System.

8.4 Disposal and recycling



The Ubbink Battery Energy Storage System must not be disposed of with household waste / residual waste. Ensure safe and proper disposal, especially of parts or materials that are harmful to the environment. The disposal of the Ubbink Battery Energy Storage System is governed by local disposal regulations and environmental laws.

Commission an authorised specialist company to dispose of the waste to avoid any dangers to the environment. The local municipal authority can provide you with information on this.

Properly dispose of materials that can be recycled with consideration for our environment.

The packaging material consists of plastic, cardboard and polystyrene. Separate the packaging material according to material and recycle it in an environmentally friendly manner.

For more information, please contact Ubbink Customer Support.

9. Appendix

9.1 Software parameters

9.1.1 Home

Parameters	Unit	Description
SoC	%	Battery state of charge - 0 to 100
Capacity	Wh	Available battery energy
Solar power	W	Effective solar power
Daily	Wh	Solar power produced daily
Grid power	W	Live grid power (IN / OUT)
EPS power	W	Effective EPS power (IN / OUT)
Parameters		Parameters menu

Table 22 Parameters in the Home screen (start screen)

9.1.2 Battery

Parameters	Unit	Description
Voltage (V)	Vdc	Live battery voltage
Current (A)	A	Live battery power
Power (W)	W	Live battery power
Temperature (°C)	°C	Live battery temperature
SoC (%)	%	Live state of charge of the battery
Current Limit (A)	A	Set limit value for battery current
Charge Voltage (V)	Vdc	Set limit value for battery voltage
Safety Voltage (V)	Vdc	Fixed battery safety limit
Day Charge (Wh)	Wh	Day battery charge
Day Discharge (Wh)	Wh	Day battery discharge

Table 23 Parameters in the Battery screen

9.1.3 Solar power

Parameters	Unit	Description
Voltage (V)	Vdc	Live Solar Voltage
Current (A)	A	Live solar power
Power (W)	W	Live Solar Power

Table 24 Parameters in the Solar Power screen

9.1.4 Power grid 1

Parameters	Unit	Description
L1 L2 L3	L	Active network phases
Voltage (V)	Vac	Voltage of the active phase
Current (A)	A	Current of the active phase
Power (W)	W	Power of the active phase

Table 25 Parameters on the Power grid 1 screen

9.1.5 Power grid 2

Parameters	Unit	Description
Daily Grid Draw	Wh	Daily energy drawn from the grid
Total Grid Draw	kWh	Grid energy drawn over the entire service life
Daily Grid Feed	Wh	Daily energy fed into the grid
Total Grid Feed	kWh	Energy fed into the grid over the entire service life
Inverter Temp	°C	Internal temperature of the inverter
Ambient Temp	°C	Ambient temperature in the room

Table 26 Parameters on the Power grid 2 screen

9.1.6 EPS 1

Parameters	Unit	Description
L1 L2 L3	L	Active network phases
Voltage (V)	Vac	Active EPS voltage
Current (A)	A	Effective EPS current
Power (W)	W	Active EPS power

Table 27 Parameters on the EPS 1 screen

9.1.7 EPS 2

Parameters	Unit	Description
Day Discharge	Wh	Daily energy drawn from the EPS
Discharge Total	kWh	EPS energy drawn over the entire service life

Table 28 Parameters on the EPS 2 screen

9.1.8 Settings

Parameters	Unit	Description
Settings		Menu
Alarms		Menu
About		Menu
Reset		Menu
Profiles		Menu
Battery settings		Menu
Grid Standards		Menu
Function Settings		Menu
Operational Settings		Menu
Time Settings		Menu
Language		Menu

Table 29 Parameters in the Settings screen

9.1.9 Profiles

Parameters	Unit	Description
Self consumption		Settings menu
Peak shift		Settings menu
Battery priority		Settings menu

Table 30 Parameters in the Profiles screen

9.1.10 Peak shift

Parameters	Unit	Description
Time Period 1		Settings menu
Charge Time (hh:mm)	hh:mm	Settings menu
Discharge Time (hh:mm)	hh:mm	Settings menu

Table 31 Parameters in the Peak Shift screen

9.1.11 Battery settings

Parameters	Unit	Description
Minimum SoC (%)	%	Settings for the lowest depth of discharge
Max. charge current (A)	A	Settings for the maximum charging current

Table 32 Parameters in the Battery Settings screen

9.1.12 Electrical Grid Standards

Parameters	Unit	Description
AT		Austria
BE		Belgium
FR		France
DE		Germany
IT		Italy
LU		Luxembourg
NL		The Netherlands
UK		United Kingdom

Table 33 Parameters in the Electrical Grid Standards screen

9.1.13 Function Settings

Parameters	Description
EPS	Release of grid-independent operation, whether the system can operate independently of the power grid in case of grid malfunctions
Battery-Wakeup	Only applicable for low voltage batteries
Remote Control	Reserve
Anti Reverse	If green (active): No feed into the grid
Home Load	If green (active): Calculates the load power of the grid terminal between the inverter and the grid current transformer
CT Ratio	Ratio of the mains current transformer (default value 1000, i.e. 1000:1)
PV Input Mode	PV input type
Independent	PV1 and PV are part of different PV strings and are independent of each other
Parallel Mode	PV1 and PV are part of one PV string and share the same set of strings
Constant voltage	PV connection is connected to a DC voltage source used for testing

Table 34 Parameters in the Function Settings screen

9.1.14 Operational Settings 1

Parameters	Unit	Description
React Mode		Reactive power control mode
Power Factor		The reactive power is regulated by the power factor
React Power		The reactive power is controlled according to the reactive power setpoint value
QU Wave		The reactive power is regulated depending on the mains voltage
QP Wave		The reactive power is controlled as a function of the active power (cos (P))
Grid Power	%	Used to limit the maximum power of the mains terminal
Discharge Power	%	Used to limit the maximum discharge power of the battery
PV Power	%	Reserved
Vac-Min	Vac	This parameter is used to set the lower limit protection value of the mains voltage if the grid standard is set to "User-defined", otherwise it is invalid.
Vac-Max	Vac	This parameter is used to set the upper protection limit value of the mains voltage if the grid standard is set to "User-defined", otherwise it is invalid.
Fac-Min	Hz	This parameter is used to set the lower limit value for the rated voltage if the grid standard is set to "User-defined", otherwise it is invalid.
Fac-Max	Hz	This parameter is used to set the upper protection limit value of the rated voltage if the grid standard is set to "User-defined", otherwise it is invalid.

Table 35 Parameters in the Operational Settings 1 screen

9.1.15 Operational Settings 2

Parameters	Unit	Description
ACTIVE ISLANDING		If green (active): Islanding protection
ISO-MONITOR		If green (active): Insulation detection
LEAK CURRENT		If green (active): Leakage current protection
PFC-VOLT RES		Reserved (reaction to charge current mains voltage)
PFC-FREQ RES		Reserved (reaction to the frequency of the charging power grid)
PWR-VOLT RES		Reaction of the discharge network to the voltage
PWR-FREQ RES		Frequency response of the discharge grid

Table 36 Parameters in the Operational Settings 2 screen

9.1.16 Time settings

Parameters	Unit	Description
Date (dd/mm/yy)	dd.mm.yyy	Setting of the system date
Time (hh:mm)	hh:mm	Setting of the system time
Mon	Monday	
Tue	Tuesday	
Wed	Wednesday	
Thur	Thursday	Setting of the system weekday
Fri	Friday	
Sat	Saturday	
Sun	Sunday	

Table 37 Parameters in the Time settings screen

9.1.17 Faults

Parameters	Unit	Description
Faults		Active faults
About		System information
Reset		Menu for resetting the system to factory settings
Date		Identification number of the system
Info		QR code for this Operating instructions

Table 38 Parameters in the Faults screen

9.2 Ubbink Warranty

To access the Ubbink warranty conditions, please access Ubbink.com



ENERGY



VENTILATION



BUILDING

Customer Support - @ service@ubbink.com

The Netherlands • 📞 +31 313 480-300 • @ productadvieslijn@ubbink.nl

France • 📞 +33 (0)2 51 13 46 46 • @ ubbink@ubbink.fr

Belgium • 📞 +32 9 237 11 00 • @ info.bouw@ubbink.be

United Kingdom • 📞 +44 1604 433-000 • @ info@ubbink.co.uk

Germany • 📞 +49 2301 91011-0 • @ info@ubbink.de

Italy • 📞 +39 045 602 0433 • @ info@ubbink.it



Ubbink International

@ info@ubbink.com • 🌐 www.ubbink.com

Copyright © 2024 Ubbink | Content is subject to change without notice; no liability for errors and misprints.
Availability and configurations may differ per country | UB-2024-12-V01

100000072416